



BERNINA 540

User manual

LOOKING FOR A NEW SEWING PROJECT?

You can find what you want in "inspiration", our sewing magazine. Thanks to great sewing patterns and detailed sewing instructions, every project succeeds right away.

Inspiration magazine
is available in German, English,
French and Dutch



* Not available in all countries.

Table of Contents

IMPORTANT SAFETY INSTRUCTIONS	9	2.4 Spool pin	31
Important information	11	Retractable spool pin	31
1 My BERNINA	13	Horizontal spool pin	32
1.1 Introduction	13	2.5 Free arm	33
1.2 BERNINA Quality control	13	2.6 Feed dog	33
1.3 Welcome to the world of BERNINA	13	Adjusting the feed dog	33
1.4 Overview Machine	15	2.7 Slide-on table	34
Overview front controls	15	Using the slide-on table	34
Overview front	16	2.8 Presser foot	35
Overview sideways	17	Adjusting the presser foot position via the knee lifter of the Free Hand System	35
Overview back	18	Adjusting the presser foot position via the button «Presser foot up/down»	35
1.5 Supplied accessories	19	Changing the presser foot	35
Overview accessories machine	19	Having the presser foot displayed in the User Interface .	36
Use of the power cable (only USA/Canada)	20	Adjusting the presser foot pressure	36
Overview presser feet	21	2.9 Instruction for adjusting the feed dog	37
Accessory box	22	2.10 Needle and stitch plate	37
1.6 Overview User Interface	22	Changing the needle	37
Overview functions/visual information	22	Selecting the needle in the User Interface	37
Overview System settings	23	Selecting the needle type and the needle size	37
Overview selection menu sewing	23	Adjusting the needle position up/down	38
Overview Icons	23	Adjusting the needle position left/right	38
1.7 Needle, Thread, Fabric	24	Needle stop up/down (permanent)	39
Overview Needles	24	Changing the stitch plate	39
Example for needle description	26	Selecting the stitch plate in the User Interface	39
Thread selection	26	2.11 Threading	40
Needle/thread combination	27	Threading the upper thread	40
2 Sewing preparation	28	Threading the double needle	42
2.1 Accessory box	28	Threading the Triple Needle	43
Removing and attaching the accessory box	28	Winding the bobbin thread	43
Storing accessories	28	Threading the bobbin thread	44
2.2 Connection and Switching on	29	Instruction how to thread the bobbin thread	46
Connecting the foot control	29	3 Setup Program	47
Connecting the machine	29	3.1 Sewing settings	47
Attaching the knee lifter of the Free Hand System	29	Adjusting the upper thread tension	47
Fixing the touchscreen pen	30	Adjusting the maximum sewing speed	47
Switching the machine on	30	Programming securing stitches	47
2.3 Foot control	30	Programming the button «Thread cutter»	48
Regulating the speed via the foot control	30	Programming the button «Securing»	48
Raising/Lowering the needle	31	Programming the button «Quick reverse»	49



3.2	Embroidery settings	49	5.4	Editing stitch patterns	67
	Adjusting the upper thread tension	49		Changing the stitch width	67
	Adjusting the maximum embroidering speed	50		Changing the stitch length	67
	Setting the embroidery motif position when opening ..	50		Correcting the balance	68
	Calibrating the hoop	51		Programming pattern repeat	68
	Entering the fabric thickness	51		Mirror image of stitch patterns	69
	Programming securing stitches (Smart Secure)	52		Quick reverse	69
	Adjusting the thread cut	52		Permanent Quick reverse	69
	Changing the measuring unit	53		Backstepping	69
3.3	Selecting personal settings	54	5.5	Combining stitch patterns	70
3.4	Monitoring functions	55		Overview Combi mode	70
	Activating the upper thread indicator	55		Creating Stitch pattern combinations	70
3.5	Activating the audio signals	55		Saving a stitch pattern combination	70
3.6	Machine settings	56		Loading a stitch pattern combination	71
	Selecting a language	56		Overwriting a stitch pattern combination	71
	Adjusting the brightness of the display	56		Deleting a stitch pattern combination	71
	Adjusting the sewing light	56		Editing a single stitch pattern	71
	Checking the firmware version	57		Deleting a single stitch pattern	72
	Reviewing the total number of stitches	57		Adding a single stitch pattern	72
	Registering details of the dealer	57		Mirroring a stitch pattern combination	72
	Saving Service data	58		Stitch pattern combination Subdivider 1	73
	Back to basic setting	59		Stitch pattern combination Subdivider 2	73
	Deleting user data	59		Securing a stitch pattern combination	73
	Deleting motifs on the BERNINA USB Stick	60		Programming pattern repeat	74
	Calibrating the Buttonhole foot No. 3A	60	5.6	Administering stitch patterns	74
	Updating the machine Firmware	61		Saving settings of stitch patterns	74
	Recovering saved data	62		Saving stitch patterns in personal memory	74
	Cleaning the thread catcher	62		Overwriting stitch patterns from the personal memory .	75
	Lubricating the machine	63		Loading stitch patterns from the personal memory	75
	Packing the embroidery module	64		Deleting stitch patterns from the personal memory	75
				Saving stitch patterns on the BERNINA USB stick	75
4	System settings	65		Uploading a stitch pattern from the BERNINA USB stick	76
				76
4.1	Calling up the Tutorial	65		Deleting stitch patterns from the BERNINA USB stick	76
4.2	Calling up the Creative Consultant	65	5.7	Securing	76
4.3	Using eco mode	65		Securing a seam with the button «Securing»	76
4.4	Calling up the Help	65		Securing via the icon «Securing»	77
4.5	Cancelling any alterations with «clr»	65	5.8	Height Compensation of uneven layers	77
5	Creative sewing	66	5.9	Sewing Corners	78
			6	Practical stitches	79
5.1	Overview selection menu sewing	66			
	Selecting a stitch pattern	66	6.1	Overview Practical stitches	79
5.2	Regulating the speed	66	6.2	Sewing straight stitch	81
5.3	Adjusting the upper thread tension	66	6.3	Securing with the automatic Securing Program	82
			6.4	Sewing in the zipper	82

6.5	Sewing both sides of the zipper from bottom to top	83	9.5	Cord	105
6.6	Sewing triple straight stitch	84		Using cord with the Buttonhole foot with slide No. 3A ..	105
6.7	Sewing Triple zig zag	85		Using cord with the Buttonhole foot No. 3C (optional accessory)	106
6.8	Manual darning	85	9.6	Sewing a test sample	107
6.9	Automatic darning	87	9.7	Determining the buttonhole slit width	107
6.10	Reinforced darning, automatic	88	9.8	Determining the buttonhole length with the Buttonhole foot with slide No. 3A	108
6.11	Reinforced Darning Program	88	9.9	Determining the buttonhole length with Buttonhole foot No. 3C (optional accessory)	108
6.12	Finishing edges	89	9.10	Sewing a buttonhole automatically	109
6.13	Sewing Double overlock	89	9.11	Programming the Heirloom buttonhole	110
6.14	Narrow edgestitching	90	9.12	Sewing the manual 7-step buttonhole with the Buttonhole foot No. 3C (optional accessory)	110
6.15	Wide edgestitching	90	9.13	Sewing the manual 5-step buttonhole with the Buttonhole foot No. 3C (optional accessory)	111
6.16	Edgestitching using the seam guide (optional accessory)	91	9.14	Cutting the buttonhole open with the seam ripper ..	111
6.17	Sewing hem edges	91	9.15	Cutting open buttonholes with the buttonhole cutter (optional accessory)	112
6.18	Sewing blind hems	92	9.16	Sewing on buttons	112
6.19	Sewing visible hems	93	9.17	Sewing eyelets	113
6.20	Sewing flat joining seams	93	10	Quilting	114
6.21	Sewing basting stitches	94	10.1	Overview Quilt Stitches	114
7	Decorative stitches	95	10.2	Quilting, Securing Program	115
7.1	Overview Decorative Stitches	95	10.3	Sewing handlook quilt stitches	115
7.2	Bobbin-Play	96	10.4	Guiding the quilt work freely	116
7.3	Sewing cross stitches	97	11	BERNINA Stitch Regulator (BSR)	117
7.4	Pintucks	97	11.1	BSR mode 1	117
	Pintucks	97	11.2	BSR mode 2	117
	Overview pintucks	97	11.3	BSR function with Straight stitch No. 1	117
	Inserting the cord	98	11.4	BSR function with Zig zag No. 2	117
	Sewing Pintucks	99	11.5	Sewing preparations for quilting	117
8	Alphabets	100		Attach the BSR presser foot	117
8.1	Overview Alphabet	100		Changing the presser foot sole	118
8.2	Creating lettering	100	11.6	Using the BSR mode	118
8.3	Altering font size	101	11.7	Securing	119
9	Buttonholes	102		Securing in BSR1 mode with the button «Start/Stop» ...	119
9.1	Overview Buttonholes	102		Securing in BSR2 mode	119
9.2	Making use of the height compensation tool	103	12	My BERNINA Embroidery	121
9.3	Using the compensation plate	104	12.1	Overview Embroidery module	121
9.4	Marking buttonholes	104			



12.2	Supplied accessories Embroidery module	121	13.6	Embroidery hoop	132
	Overview accessory Embroidery module	121		Overview Embroidery hoop selection	132
12.3	Overview User Interface	122		Selecting the embroidery hoop	132
	Overview functions/visual information	122		Tear-away stabilizers	133
	Overview System settings	123		Cut-away stabilizers	133
	Overview Selection menu embroidery	123		Using adhesive spray	133
12.4	Important Embroidery information	123		Using spray starch	133
	Upper thread	123		Using iron-on interfacing	133
	Bobbin thread	124		Using paper-backed adhesive stabilizer	133
	Selecting the embroidery file format	124		Using water-soluble stabilizer	134
	Embroidery test	125		Preparing the embroidery hoop	134
	The size of the embroidery motif	125		Attaching the hoop	135
	Embroidering motifs by third-party providers	125		Overview Embroidery functions	136
	Underlay stitches	125		Center the needle to the embroidery hoop	136
	Satin or Leaf stitch	125		Moving the hoop to the back	136
	Step stitch	126		Moving the module for the sewing mode	136
	Connecting stitches	126		Grid on/off	137
13	Embroidering preparation	127	14	Setup Program	138
13.1	Attaching the Module	127	14.1	Adjusting the embroidery settings in the Setup Program	138
13.2	Removing the embroidery module	127	15	Creative embroidering	139
13.3	Preparing the machine	128	15.1	Overview embroidering	139
	lower the feed-dog	128	15.2	Selecting and changing the embroidery motif	139
	Selecting an embroidery motif	128	15.3	Checking the embroidery time and the embroidery motif size	139
13.4	Embroidery foot	128	15.4	Regulating the speed	139
	Attaching the embroidery foot	128	15.5	Editing the embroidery motif	140
	Selecting the presser foot in the User Interface	129		Overview Editing embroidery motif	140
13.5	Needle and stitch plate	129		Scaling up the embroidery motif view	140
	Inserting the embroidery needle	129		Downsizing the embroidery motif view	140
	Selecting the embroidery needle in the User Interface ..	130		Moving the embroidery motif view	140
	Selecting the needle type and the needle size	130		Moving the embroidery motif in enlarged view	141
	Adjusting the needle position up/down	131		Moving the embroidery motif	141
	Attaching the stitch plate	131		Rotating motif	141
	Selecting the stitch plate in the User Interface	132		Altering the embroidery motif size proportionally	142
	Thread-up command	132		Altering the embroidery motif size disproportionately	142
				Mirroring embroidery motifs	143
				Bending the text	143
				Changing the stitch type	144
				Altering the stitch density	144
				Checking the size and the position of the embroidery motif	144
				Duplicating the embroidery motif	145
				Deleting an embroidery motif	146

15.6	Combining embroidery motifs	146	17	Appendix	159
	Combining embroidery motifs	146	17.1	Maintenance and cleaning	159
	Deleting a single embroidery motif	146		Cleaning the display	159
	Duplicating a combination	146		Cleaning the feed dog	159
15.7	Creating lettering	147		Cleaning the hook	159
	Overview embroidery alphabets	147		Lubricating the hook	160
	Creating words/sentences	147	17.2	Troubleshooting	162
	Editing words/sentences	148	17.3	Error messages	164
15.8	Changing the colors of the embroidery motif	149	17.4	Storage and disposal	168
	Overview changing the color	149		Storing the machine	168
	Changing the colors	150		Dispose of the machine	168
	Changing the thread brand	150	17.5	Technical data	168
15.9	Embroidering the embroidery motif	150	18	Overview stitch patterns	170
	Overview Embroidery menu	150	18.1	Overview Stitch patterns	170
	Adding basting stitches	151		Practical stitches	170
	Moving the hoop	151		Buttonholes	170
	Embroidery sequence control when thread breaks	151		Decorative stitches	170
	Cutting connecting stitches	151	18.2	Overview Embroidery motifs	173
	Reducing color changes	152		Editing embroidery motifs	173
	Multi-colored embroidery motif on/off	152		Quilt motifs	174
	Color indication	152		Ornaments	175
15.10	Free arm embroidering	152		Flowers	175
15.11	Administering embroidery motifs	153		Children	176
	Administering embroidery motifs	153		Seasons	176
	Saving embroidery motifs in the personal memory	153		Sports and hobby	177
	Saving the embroidery motif on the BERNINA USB stick	154		Animals	178
	Overwriting the embroidery motif in the personal memory	154		Borders and Lace	179
	Overwriting the embroidery motif on the BERNINA USB stick	154		Frames and borders	179
	Importing stitch patterns	155		Designs with special effects	180
	Loading an embroidery motif from the personal memory	155		Index	181
	Loading an embroidery motif from the BERNINA USB stick	155			
	Deleting an embroidery motif from the personal memory	155			
	Deleting an embroidery motif from the BERNINA USB stick	156			
16	Embroidery	157			
16.1	Embroidering via the button «Start/Stop»	157			
16.2	Increasing the embroidery speed	157			
16.3	Adjusting the upper thread tension	157			
16.4	Embroidering via the foot control	158			



IMPORTANT SAFETY INSTRUCTIONS

Please be aware of the following basic safety instructions when using your machine. Before using this machine, read instruction manual carefully.

DANGER!

To reduce the risk of electrical shock:

- Never leave the machine unattended as long as it is plugged in.
- Always unplug the machine from the electrical outlet immediately after using.

Protection against LED radiation:

- Do not view the LED light directly with optical instruments (e.g. magnifier). The LED light corresponds with protection class 1M.
- When the LED light is damaged or defective, contact your BERNINA specialist dealer.

WARNING

To reduce the risk of burns, fire, electric shock or injury to persons:

- To operate the machine always use the supplied power cable. USA and Canada only: Do not connect power plug NEMA 1-15 to circuits exceeding 150 volt-to-ground.
- Use this machine only for purposes as described in this manual.
- Only use the machine in dry rooms.
- Do not use the machine in a damp condition or in a damp environment.
- Do not use this machine as a toy. Close attention is necessary when this machine is used by or near children.
- The machine can be used by children older than 8 or by people with reduced physical, sensory or mental capabilities or if there is a lack of experience and knowledge how to operate the machine as long as they are supervised or have been given instruction concerning the responsible use of the appliance and are aware of the involved risks.
- Children are not allowed to play with this machine.
- Cleaning and maintenance work must not be carried out by children unless they are supervised.
- Never operate this machine if it has a damaged cord or plug, if it is not working properly, if it has been dropped or damaged, or dropped into water. Contact the nearest authorized BERNINA dealer to arrange further details.

- Only use accessory recommended by the manufacturer.
- Don't use this machine when the ventilation openings are blocked. Keep the ventilation openings and the foot control free from the accumulation of lint, dust and loose cloth.
- Never insert any objects into any openings of the machine.
- Do not place any objects on the foot control.
- Always use the machine with a foot control of this type LV-1.
- Do not operate the machine where aerosol products (sprays) or oxygen are being used.
- Keep fingers away from all moving parts. Special care is required around the needle.
- Neither pull nor push the fabric while sewing. This can cause needle breakage.
- When making any adjustments in the needle area – such as such as threading the needle, changing the needle, threading the hook or changing the presser foot – turn power switch to «0».
- Do not use bent needles.
- Always use the original BERNINA stitch plate. The wrong stitch plate can cause needle breakage.
- To disconnect, turn power switch to «0» and then remove the plug from the outlet. Do not unplug by pulling the cord, instead grasp the plug to pull it from the outlet.
- Always disconnect the power plug from the electrical outlet when the covers are removed or opened, when the machine is lubricated or during any other maintenance adjustments mentioned in the instruction manual.
- This machine is provided with double insulation (except USA, Canada and Japan). Use only identical replacement parts. See instructions for Servicing of double-insulated products.
- The sound pressure level is lower than 70 dB(A) under normal conditions.



Important information

Availability of the instruction manual

The instruction manual is supplied with the machine.

- Keep the instruction manual safe at a suitable place near the machine to have it at hand in case that you need to look up something.
- If you pass the machine to a third party, always include the instruction manual.

Proper use

Your BERNINA machine is conceived and designed for private household use. It is intended for sewing fabrics and other materials as described in this instruction manual. Any other use is not considered proper. BERNINA assumes no liability concerning consequences resulting from an improper use.

Equipment and scope of delivery

Example images are used in these operating instructions for the purposes of illustration. The machines shown in the images and the accessories shown therefore do not always match the actual items included with your machine. The supplied accessory can vary depending on the country of delivery. Accessories mentioned or shown which are not included in the scope of delivery can be purchased as special accessories from a BERNINA specialist dealer. Further accessories can be found at <https://www.bernina.com>.

For technical reasons and in order to improve the product, changes may be made to the equipment of the machine and the scope of delivery at any time and without prior notice.

Maintenance of double-insulated products

In a double-insulated product, two systems of insulation are provided instead of grounding. No grounding means is provided on a double-insulated product nor should a means for grounded be added to the product. Servicing a double-insulated product requires extreme care and knowledge of the system and should only be done by qualified service personnel. Only original spare parts should be used for service and repairs. A double-insulated product is marked with the words: «Double-Insulation » or «double-insulated».

 The symbol may also be marked on the product.

Environmental Protection

BERNINA is committed to the protection of the environment. We strive to minimize the environmental impact of our products by continuously improving product design and our technology of manufacturing.



The machine is labeled with the symbol of the crossed-out wastebin. This means that the machine must not be disposed of with the household waste when the machine is no longer needed. Improper disposal can result in dangerous substances getting into the groundwater and thus into our food chain, damaging our health.

The machine must be returned free of charge to a nearby collection point for waste electrical and electronic equipment or to a collection point for the reuse of the machine. Information on the collection points can be obtained from your local administration. When purchasing a new machine, the dealer is obliged to take back the old machine free of charge and dispose of it properly.

If the machine contains personal data, you are responsible for deleting the data yourself before returning the machine.

Explanation of symbols



Designates a high-risk hazard which can lead to serious injuries or potentially even death if not avoided.



Designates a medium-risk hazard which can lead to serious injuries if not avoided.



Designates a low-risk hazard which can lead to minor or moderate injuries if not avoided.



Designates a hazard which can lead to material damage if not avoided.



Tips from BERNINA **sewing experts** are found next to this symbol.

1 My BERNINA

1.1 Introduction

With your BERNINA 540 you can sew, embroider and quilt. Delicate silk or satin fabrics as well as heavy-weight linen, fleece and denim can be sewn without any problems with this machine. Numerous practical as well as decorative stitches, buttonholes and embroidery motifs are at your disposal.

Additional to this instruction manual, subsequently listed help programs are provided which will give you useful advice and support at any time how to operate your BERNINA 540.

The **Tutorial** gives information and explanations, covering various aspects of sewing, embroidering and the different stitches.

The **Creative Consultant** informs you about decision support for sewing projects. After entering the kind of fabric and the desired sewing project, suggestions concerning the suitable needle or the appropriate presser foot are displayed.

The **Help Program** contains information about individual stitch patterns, functions and applications in the display.

Further information

In addition to this instruction manual of your BERNINA 540 further information products are enclosed.

The latest version of your instruction manual as well as additional information in connection with the machine and accessories can be found on our website <http://www.bernina.com>

1.2 BERNINA Quality control

All BERNINA machines are assembled with utmost care and are subjected to an extensive functionality test. The integrated stitch counter therefore indicates that the machine has already sewn stitches, which were performed exclusively for test purposes and quality control. The subsequent thorough cleaning does not exclude the possibility that thread remnants may still be found in the machine.

1.3 Welcome to the world of BERNINA

Made to create this is the slogan of BERNINA. Not only with our machines do we support you in the implementation of your ideas. In addition to the offers listed below, we offer you lots of suggestions and instructions for your future projects as well as the opportunity to exchange ideas with other sewing, quilting and embroidery enthusiasts. I wish you lots of pleasure.

BERNINA YouTube Channel

On YouTube we offer a wide range of how-to videos and support concerning the most important functions of our machines. Detailed explanations are also provided as for the various presser feet, so that your projects will succeed completely.

<http://www.youtube.com/BerninaInternational>

Provided in the languages English and German.

inspiration – the sewing magazine

Are you looking for ideas and instructions for great projects? In that case the BERNINA magazine «inspiration» is exactly what you need. «inspiration» offers extraordinary sewing and embroidery ideas four times a year. From seasonal fashion trends to trendy accessories and practical tips to decorate your home in an original way.

<http://www.bernina.com/inspiration>

The magazine is available in the languages English, German, Dutch and French. Not available in all countries.



BERNINA Blog

Fancy instructions, free sewing patterns and embroidery motifs as well as many new ideas: all this you can find in the weekly blog by BERNINA. Our experts give valuable tips and explain step by step how you can achieve the desired result. In the community you can upload your own projects and exchange experiences and ideas with other sewing and embroidering enthusiasts.

<http://www.bernina.com/blog>

Provided in the languages English, German and Dutch.

BERNINA Social Media

Follow us on the social networking to learn more about events, thrilling projects as well as tips and tricks all about sewing, quilting and embroidering. We will keep you informed and we are looking forward to presenting you the one or the other highlight from the world of BERNINA.

<http://www.bernina.com/social-media>



1.4 Overview Machine

Overview front controls



- 1 Quick reverse
- 2 Thread cutter
- 3 Securing
- 4 Start/Stop
- 5 Pattern end

- 6 Needle up/down
- 7 Presser foot pressure
- 8 Upper multifunction knob
- 9 Lower multifunction knob
- 10 Needle left/right

Overview front



- | | | | |
|---|---|----|---------------------------------|
| 1 | Connection for embroidery module | 9 | Thread take-up lever cover |
| 2 | Bobbin cover | 10 | Presser foot pressure |
| 3 | Connection for accessory (optional accessory) | 11 | Thread take-up lever |
| 4 | Presser foot | 12 | Thread cutter |
| 5 | Needle threader | 13 | Fixing screw |
| 6 | Sewing light | 14 | Connection for slide-on table |
| 7 | Thread cutter | 15 | Connection for Free Hand System |
| 8 | Speed control | | |

Overview back



- | | | | |
|---|-------------------------------|----|----------------------|
| 1 | Air vents | 9 | Bobbin winding unit |
| 2 | Connection for slide-on table | 10 | Thread pretension |
| 3 | Connection for darning hoop | 11 | Thread take-up lever |
| 4 | Presser foot lifter | 12 | Thread guide |
| 5 | Carrying handle | 13 | Thread cutter |
| 6 | Spool pin | 14 | BSR connection |
| 7 | Thread guide | 15 | Feed dog |
| 8 | Retractable spool pin | 16 | Stitch plate |

1.5 Supplied accessories

Overview accessories machine

















Illustration	Name	Purpose
	Dust cover	To protect the machine from dust and contamination.
	Accessories box	To store the supplied accessories as well as the optional accessories.
	Free Hand System (FHS)	To raise and lower the presser foot.
	Slide-on table	To increase the sewing surface.
	Spool disc	To support the regular unwinding of the thread from the spool. 3 different sizes for thread spools in different sizes.
	Bobbin 4 pieces, 1 of them in the machine	To wind the bobbin thread.
	Foam pad 2 pieces	To prevent the thread from slipping under the spool holder, tangling and breaking.
	Touchscreen pen	For precise operation of the touch display.
	Seam ripper	To undo seams and to cut buttonholes open.

Illustration	Name	Purpose
	Height compensating tool	To level an angled position of the presser foot sole when sliding over thick seams.
	Selection of needles	For any common applications.
	Screwdriver red (slot)	To loosen and tighten slotted screws.
	Brush	To clean the feed dog and the looper area.
	Sewing machine oil	To oil the machine.
	Power cable	To connect the machine with the power supply system.
	Foot control	To start and stop the machine. To control the sewing speed.









Use of the power cable (only USA/Canada)

The machine has a polarized plug (one blade wider than the other). To reduce the risk of electrical shock, this plug is intended to fit in a polarized outlet only one way. If the plug does not fit fully in the outlet, reverse the plug. If it still does not fit, contact a qualified electrician to install the proper outlet. Do not modify the plug in any way!

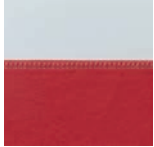

Overview presser feet

Supplied standard presser feet

Illustration	Number	Name	Purpose	Example
	#1C	Reverse pattern foot	To sew various practical and decorative stitches. To sew forward and in reverse.	
	#2A	Overlock foot	To finish edges in stretch material.	
	#3A	Automatic Buttonhole foot with slide	To sew buttonholes automatically.	
	#4	Zipper foot	To sew in zippers.	
	#20C	Open embroidery foot	To sew appliqués and decorative patterns.	

Accessory box



- | | | | |
|---|---------------|---|---|
| 1 | Drawer | 5 | Foam pad |
| 2 | Presser feet | 6 | Automatic Buttonhole foot with slide |
| 3 | Bobbin holder | 7 | Selection of needles |
| 4 | Spool discs | 8 | Holder for 5.5 mm and 9.0 mm presser feet |

1.6 Overview User Interface

Overview functions/visual information

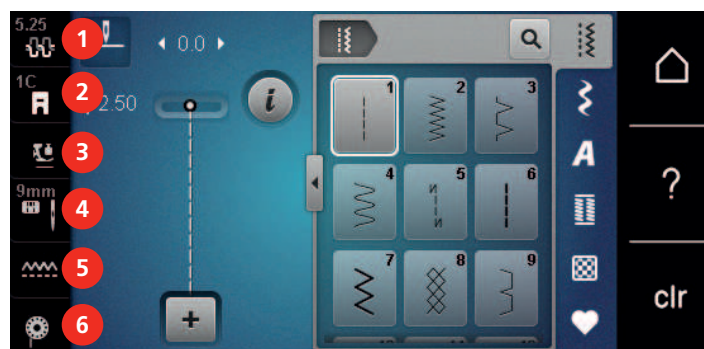

- | | | | |
|---|------------------------|---|---|
| 1 | Upper thread tension | 4 | Stitch plate/Needle selection |
| 2 | Presser foot indicator | 5 | Feed dog up/down |
| 3 | Presser foot pressure | 6 | Instruction how to thread the bobbin thread |

Overview System settings

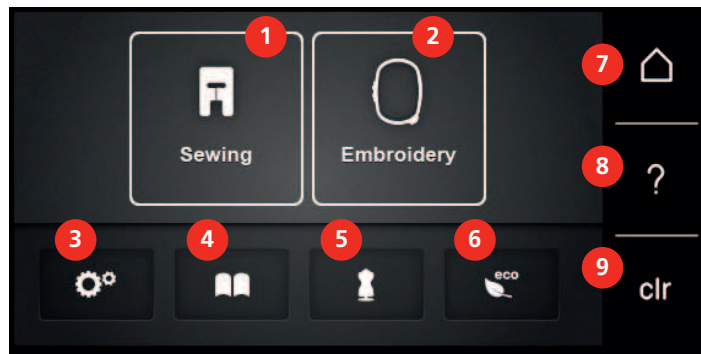



- | | | | |
|---|---------------------|---|-------------------------|
| 1 | Sewing mode | 6 | eco mode |
| 2 | Embroidery mode | 7 | Home |
| 3 | Setup Program | 8 | Help |
| 4 | Tutorial | 9 | Back to default setting |
| 5 | Creative Consultant | | |

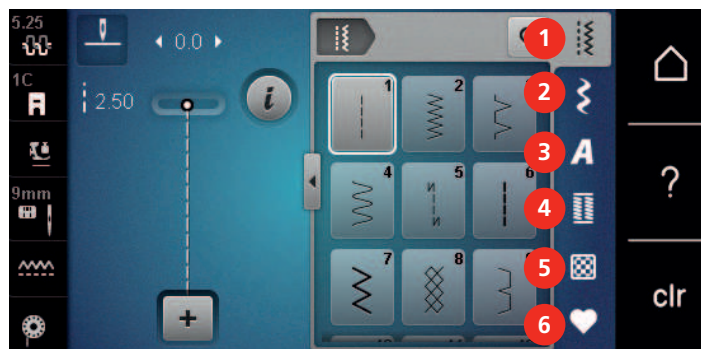







Overview selection menu sewing



- | | | | |
|---|---------------------|---|-----------------|
| 1 | Practical stitches | 4 | Buttonholes |
| 2 | Decorative stitches | 5 | Quilt stitches |
| 3 | Alphabets | 6 | Personal Memory |

Overview Icons

Icon	Name	Purpose
	i-Dialog	Under the icon «i» dialog, you can find different functions for editing patterns.
	ESC	The window is closed and the changes that were previously set are implemented.

Icon	Name	Purpose
 	Icons «-/+»	You can use the icons «-» and «+» to change setting values.
	Yellow frame around the icon	A yellow-framed icon indicates that a setting or value has been changed in this function. This can be reset to the default setting by touching the yellow-framed icon.
	Confirm	Confirms the changes that were previously made. The window is closed.
	Cancel	The process is canceled. The window is closed and the changes are not implemented.
	Slider	The slider is used to change setting values.
	Switch	The switch is used to switch functions on or off.
	Process navigation	You can use the process navigation to return to the previous display.

Please note: Some displays contain more functions than those displayed. You can display hidden functions by swiping your finger or the touchscreen pen upwards or downwards.

1.7 Needle, Thread, Fabric

In the course of time a needle wears out. Therefore it should be replaced regularly. Only a perfect point results in a good stitching result. In general it can be said: the thinner the thread, the finer the needle. The illustrated needles are either standard or optional accessory, depending on the machine.

- Needle sizes 70, 75: for thin fabrics.
- Needle sizes 80, 90: for medium fabrics.
- Needle sizes 100, 110 and 120: for heavy fabrics.

Overview Needles





Illustration	Needle name	Needle description	Purpose
 	Universal needle 130/705 H 60-120	Slightly rounded point	For nearly all natural and synthetic fabrics (woven and knitted).
 	Stretch needle 130/705 H-S 75, 90	Mid-sized ball point, special eye shape and needle scarf	For jersey, tricot, knit and stretch fabrics.

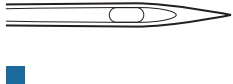
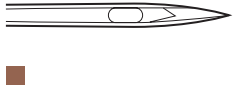
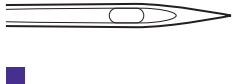

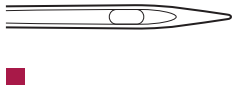

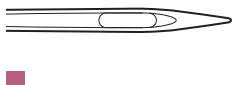
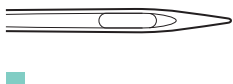
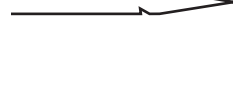





Illustration	Needle name	Needle description	Purpose
	Jersey/Embroidery needle 130/705 H SUK 60-100	Mid-sized ball point	For knitware, knitted good. For embroidering.
	Jeans needle 130/705 H-J 80-110	Point, narrow point, reinforced shaft	For heavy-weight fabrics such as jeans or canvas.
	Leather needle 130/705 H LR 90, 100	With cutting point (LR = special point to sew leather)	For all types of leather, synthetic leather, plastic, sheeting.
	Microtex needle 130/705 H-M 60-110	Especially sharp, narrow point	For micro fiber fabrics and silk.
	Quilting needle 130/705 H-Q 75, 90	Slightly rounded fine point	For straight and topstitching.
	Embroidery needle 130/705 H-E 75, 90	Small ball point, especially wide needle eye and wide thread groove	For embroidery on all natural and synthetic fabrics.
	Fine-material needle 130/705 H SES 70, 90	Small ball point	For fine knitware and knitted materials. For embroidery on fine, delicate fabrics.
	Metafil needle 130/705 H METAFIL 80	Long needle eye (2 mm) in all needle sizes	For sewing or embroidering with metallic threads.
	Cordonnet needle (to patch embroidery) 130/705 H-N 70-100	Long needle eye (2 mm) in all needle sizes	Topstitching with thick thread.
	Felt needle PUNCH	Needle with barbed hook	For felt work.
	Hemstitch needle 130/705 H WING 100-120	Wing-like widened needle shaft (wing)	To sew blind stitches.

Illustration	Needle name	Needle description	Purpose
 ☒	Universal double needle 130/705 H ZWI 70-100	Needle distance: 1.0/1.6/2.0/2.5/ 3.0/4.0/6.0/8.0	For visible hems in stretch fabrics, pintucks, decorative sewing.
 ☒	Stretch double needle 130/705 H-S ZWI 75	Needle distance: 2.5/4.0	For visible hems in stretch fabrics, pintucks, decorative sewing.
 ☒	Hemstitch double needle 130/705 H ZWIHO 100	Needle distance: 2.5	For special effects with hemstitch embroidery.
 ☒	Universal triple needle 130/705 H DRI 80	Needle distance: 3.0	For visible hems in stretch fabrics, decorative sewing.

Example for needle description

The 130/705 system, which is the most common for household machines, is explained by the following picture of a Jersey/Stretch needle.

	<p>130/705 H-S/70</p> <p>130 = Shank length (1)</p> <p>705 = Flat shank (2)</p> <p>H = Needle scarf (3)</p> <p>S = Needle point (here medium ball point) (4)</p> <p>70 = Needle size 0.7 mm (5)</p>
---	---

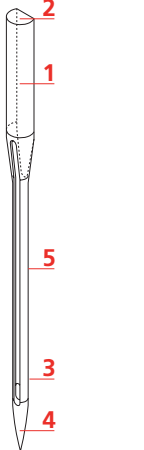
Thread selection

For a perfect sewing result, thread and fabric quality play an important role.

We recommend purchasing quality threads to achieve good sewing results.

- Cotton threads have the advantage of being a natural fiber and therefore are especially suitable for sewing cotton fabrics.
- Mercerized cotton threads have a slight sheen that is not lost with washing.
- Polyester threads have a high tensile strength and is particularly colorfast.
- Polyester threads are more flexible and are recommended where a strong and elastic seam is required.
- Rayon threads are made of natural fibers and have a brilliant sheen.
- Rayon threads are suitable for decorative stitches and achieve a more beautiful effect.

Needle/thread combination

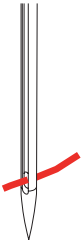
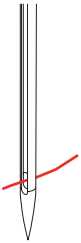
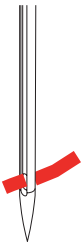
	<p>The needle/thread combination is correct, when the thread fits perfectly into the long groove and goes easily through the needle eye. The thread can be optimally secured.</p>
	<p>The thread can break and skipped stitches can occur when there is too much clearance in the long groove and the needle eye.</p>
	<p>The thread can break and get stuck when the thread scrapes against the edge of the long groove not fit well into the needle eye optimally.</p>

2 Sewing preparation

2.1 Accessory box

Removing and attaching the accessory box

The accessory box is fixed to the machine by means of four magnets. When attaching, the drawer has to be integrated in the accessory box.

- > Turn the carrying handle up and hold it in place.
- > Tilt the accessory box slightly to the front and pull off.



- > Close the doors of the accessory box.
- > Attach the accessory box to the machine, having the back towards the machine.

Storing accessories

NOTICE

Incorrect sorting of the bobbin

The silvery sensor surface can get scratched.

- > Make sure that the silvery sensor surfaces are on the right side when sorting the bobbins into the accessory box.

- > Insert the holders (1) for bobbins, feet and needles.
- > Store small parts in the drawer (2), e.g. oiler.
- > Insert the bobbins into the compartment (3) of the accessory box so that the silvery sensor surfaces are on the right side.
- > To remove a bobbin, press the compartment holder down.
- > Place small and medium-sized spool discs onto the pen (4).
- > Store foam pads in the compartment (5).
- > Store the buttonhole foot with slide No. 3A in the compartment (6).
- > Store the provided needle package in the special compartment (7).
- > Store the presser feet in the holders (1) (5.5 mm or 9.0 mm).



2.2 Connection and Switching on

Connecting the foot control

- > Unwind the cable of the foot control to the desired length.



- > Insert the cable of the foot control into the foot control connection.



Connecting the machine

- > Insert the power cable into the power cord connection.



- > Insert the power cable into the power cord connection.

Attaching the knee lifter of the Free Hand System



The lateral position of the knee lifter can be adjusted by your local BERNINA Dealer if required.

- > Insert the knee lifter into the opening at the front side of the machine.

- > Adjust the sitting height so that the knee lifter can be operated with the knee.



Fixing the touchscreen pen

- > Store the touchscreen pen at the magnet holder.



Switching the machine on

- > Switch on the machine at the main switch to «I».



2.3 Foot control

Regulating the speed via the foot control

Via the foot control the speed is infinitely variable.

- > Press the foot control down carefully to start the machine.
- > To sew faster, press the foot control harder.



- > Release the foot control to stop the machine.



Raising/Lowering the needle

- > Sink the heel back on the foot control to raise/lower the needle.



2.4 Spool pin

Retractable spool pin

Raise the retractable spool pin



With metallic or other special threads, it is recommend to use the retractable spool pin.

The retractable spool pin is required when sewing with multiple threads, and can be used for spooling while sewing.

- > To raise the spool pin, push the spool pin down and release it.



- > To lock the spool pin, turn the spool pin anti-clockwise as far as it will go.
- > To release the lock, turn the spool pin clockwise as far as it will go.
- > To lower the spool pin, push the spool pin down until it clicks into place.

Inserting foam pad and thread spool

The foam pad prevents the thread from getting hooked at the retractable spool pin.

- > Place the foam pad on the retractable spool pin.
- > Place the thread spool on the spool pin.



Horizontal spool pin

Placing the foam pad, the thread spool and the spool disc

The spool disc provides an even unwinding of the thread from the thread spool. The spool disc is only used with the horizontal spool pin.

- > Place the foam pad on the spool pin.
- > Place the thread spool on the spool pin.



- > Position the appropriate spool disc on the spool pin so that there is no space between the spool disc and the thread spool.



Using a spool net

The spool net holds the thread on the thread spool and prevents the thread from knotting and breaking.

- > If available, slide the spool net over the thread spool.



2.5 Free arm

The BERNINA 540 provides a solidly designed free arm which offers a lot of space for large project on the right of the needle.

2.6 Feed dog

Adjusting the feed dog

NOTICE

Inappropriate handling of the fabric

Damage of the needle and the stitch plate.

- > Let the sewing project be fed evenly.

With each stitch, the feed dog moves forward by one step. The length of this step is determined by the stitch length selected.

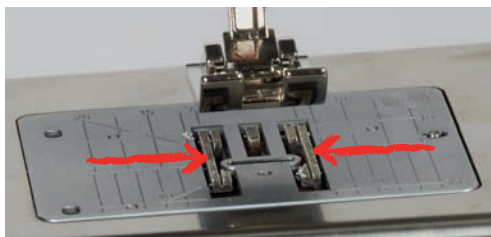

With a short stitch length, the steps are very short. For example when sewing buttonholes and satin stitches. The fabric is fed slowly under the presser foot, even when sewing at maximal speed.

Having the presser foot displayed in the User Interface

The recommended presser foot for the selected stitch is displayed. In addition to that, optional presser feet can be displayed.

- > Switch the machine on.
- > Select a stitch pattern.
 - In the icon «Presser foot display» the recommended presser foot is indicated with a number.
- > Touch the icon «Presser foot display».
- > With the touchscreen pen/finger scroll up within the range of presser feet to have optional presser feet displayed.
- > If a presser foot is touched, the description and the application for this presser foot is displayed.



Adjusting the presser foot pressure

The factory-set standard presser foot pressure can be used for all common sewing works. When working with jersey fabrics or with loose knitware, reduce the presser foot pressure. For firm materials, increase the presser foot pressure.



The presser foot pressure is designed to adjust the pressure of the presser foot optimally to the fabric thickness. When working with thick fabrics, it is recommended to reduce the presser foot pressure. This provides the advantage that the presser foot is slightly lifted so that the fabric can be moved more easily. When working with thin fabrics, it is recommended to increase the presser foot pressure. This provides the advantage that the fabric cannot be moved too easily under the presser foot.

- > Turn the knob to the right to reduce the pressure foot pressure.
- > Turn the knob further to the right to raise the presser foot.
- > Turn the knob to the left to increase the pressure foot pressure.



2.9 Instruction for adjusting the feed dog



- > Touch the icon «Feed dog up/down».
- > Raise or lower the feed dog according to the animation.

2.10 Needle and stitch plate

Changing the needle

- > Raise the needle.
- > Switch the machine off and disconnect it from the power supply system.
- > Remove the presser foot.
- > Loosen the fixing screw of the needle manually.



- > Pull the needle down.
- > Hold the new needle with the flat side to the back.
- > Insert the needle as far as it will go.
- > Tighten the fixing screw manually.

Selecting the needle in the User Interface

After having changed the needle, it can be checked whether or not it can be used in combination with the selected stitch plate.



- > Touch the icon «Stitch plate/Needle selection».



- > Select the inserted needle.

Selecting the needle type and the needle size

Convenient memory function: To prevent a loss of information, the needle type and the needle size can be saved additionally on the machine. The saved needle type and the saved needle size can be checked at any time.



- > Touch the icon «Stitch plate/Needle selection».



- > Touch the icon «Needle type/Needle size».
- > Select the needle type (1) of the inserted needle.
- > Select the needle size (2) of the inserted needle.



Adjusting the needle position up/down



- > Push the button «Needle up/down» to lower the needle.
- > Push the button «Needle up/down» again to raise the needle.

Adjusting the needle position left/right

There is a total of 11 needle positions. The needle position is indicated by the needle position number in the display.

- > Push the button «Needle left» (1) to move the needle to the left.
- > Push the button «Needle right» (2) to move the needle to the right.



Needle stop up/down (permanent)



- > Touch the icon «Needle stop up/down (permanent)» to fix the needle position permanently.
 - The machine stops with needle position down as soon as the foot control is released or the button «Start/Stop» has been pressed.
- > Touch the icon «Needle stop up/down (permanent)» again.
 - The machine stops with needle position up as soon as the foot control is released or the button «Start/Stop» has been pressed.

Changing the stitch plate

The stitch plate is marked with vertical, horizontal and diagonal lines in millimeters (mm) and inches (inch). These lines help to guide the fabric when sewing seams and precise topstitching.

Prerequisite:

- The feed dog is lowered.
 - The machine is switched off and disconnected from the power supply system.
 - Needle and presser foot are removed.
- > Press the stitch plate down at the mark back right until it flips up.



- > Remove the stitch plate.
- > Place the openings of the new stitch plate above the corresponding guide pins and press down until it clicks into place.

Selecting the stitch plate in the User Interface

After having changed the stitch plate, it can be checked whether or not it is suitable to be used in combination with the selected needle.



- > Touch the icon «Stitch plate/Needle selection».
- > Select the previously attached the stitch plate.



- If the selected stitch plate is suitable in combination with the needle, sewing can be started.
- If the selected stitch plate is not suitable in combination with the needle, starting the machine is automatically blocked.

Threading the needle

- > Guide the thread through the guides (6/7) above the presser foot.

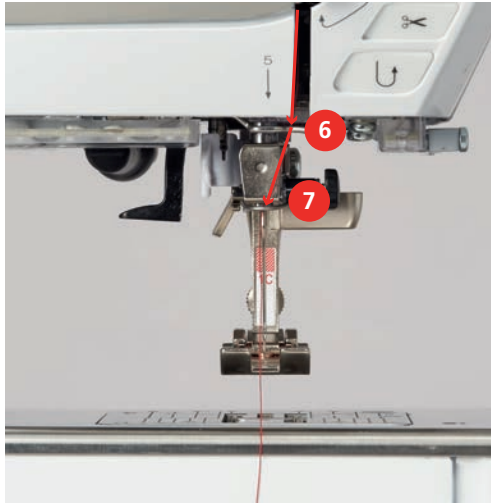

- > Push the semi-automatic needle-threading lever (8) halfway down and pull the thread behind the gray needle-threading finger/hook to the left (9).

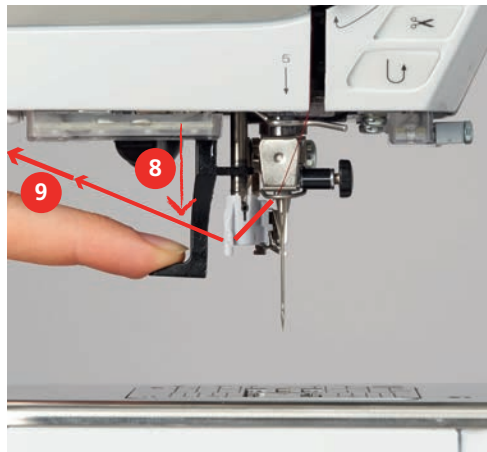

- > Guide the thread from the left to the right in front of the gray needle-threading finger/hook (11).
- > Push the needle-threading lever down as far as it will go (10).
- > Pull the thread from left to right (11) through the needle-threading slot (12) until it clips into the wire hook.
- > Pull the thread over the thread cutter (13) from the back and cut.

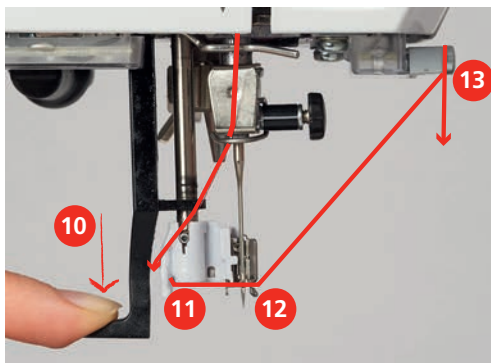

- > Release the needle-threading lever.
 - The thread is pushed through the needle eye.



- > Attach the empty bobbin on the winding unit so that the silvery sensor surface is down.



- > Guide the thread to the left into the rear thread guide (1).
- > Guide the thread around the thread pretension clockwise (2).
- > Wind the thread clockwise 2 to 3 times around the empty bobbin (3).
- > Pull the thread over the thread cutter at the engaging lever (4) and cut.

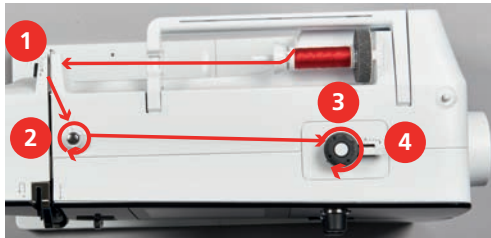

- > Push the engaging lever (5) towards the bobbin.



- The machine winds and the display to wind the bobbin appears.
- > Move the slide on the display using the touchscreen pen or the finger to adjust the winding speed.
- > To stop the winding process, the engaging lever must be pressed to the right.
- > Push the engaging lever towards the bobbin again to continue the winding process.
 - As soon as the bobbin is full, the machine stops the winding process automatically.
- > Remove the bobbin and cut the thread using the thread cutter at the engaging lever.

Threading the bobbin thread

Prerequisite:

- The needle is raised.
- The machine is switched off and the bobbin cover is opened.



- > Pull the thread to the right under the spring (3), then lead the thread under the two thread guides (4) and pull upwards.



- > When inserting into the machine, hold the bobbin case so the thread guide (5) points upwards.



- > Insert the bobbin case.
- > Press onto the center of the bobbin case until it engages.
- > Pull the thread through the thread cutter (6) and cut.



- > Close the bobbin cover.

Instruction how to thread the bobbin thread



- > Touch the icon «Bobbin thread».
- > Thread the bobbin thread according to the animation.



3 Setup Program

3.1 Sewing settings

Adjusting the upper thread tension

Changes to the upper thread tension in the Setup Program affect all of the stitch patterns. You can also make changes to the upper thread tension which then apply for the selected stitch pattern in each case. The setting in the setup is retained after the machine is switched off.



> Touch the icon «Home».



> Touch the icon «Setup Program».



> Touch the icon «Sewing settings».



> Touch the icon «Change upper thread tension».
 > To increase the upper thread tension, slide the slider to the right or touch the icon «+».
 > To decrease the upper thread tension, slide the slider to the left or touch the icon «-».

Adjusting the maximum sewing speed

You can use this function to set the maximum speed.



> Touch the icon «Home».



> Touch the icon «Setup Program».



> Touch the icon «Sewing settings».



> Touch the icon «Change maximum speed».
 > To decrease the maximum sewing speed, slide the slider to the left or touch the icon «-».
 > To increase the maximum sewing speed, slide the slider to the right or touch the icon «+».

Programming securing stitches

If the function is switched on, at the start of the pattern, four securing stitches are automatically sewn after the thread cut.



> Touch the icon «Home».



> Touch the icon «Setup Program».



> Touch the icon «Sewing settings».



> To switch off securing stitches at the start of the pattern, set the switch to «0».
> To switch on securing stitches at the start of the pattern, set the switch to «I».

Programming the button «Thread cutter»

The automatic securing can be programmed before the thread cut takes place.



> Touch the icon «Home».



> Touch the icon «Setup Program».



> Touch the icon «Sewing settings».



> Touch the icon «Program buttons and icons».



> Touch the icon «Program the button thread cutter».



> Touch the icon «Securing» to sew 4 securing stitches in place.

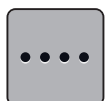

> Touch the icon «Alter the number of securing stitches» to program the number of securing stitches in close succession.
> Touch the icons «-» or «+» to program the number of securing stitches.

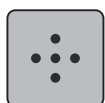

> Touch the icon «Securing stitches in place» to program 4 securing stitches in place.



> Touch the icon «Securing» deactivate the automatic securing.
> Touch the icon «Securing» again to activate the automatic securing.

Programming the button «Securing»

Number and type of securing stitches can be programmed.



> Touch the icon «Setup Program».



> Touch the icon «Sewing settings».



> Touch the icon «Setup Program».



> Touch the icon «Embroidery settings».



> Touch the icon «Change upper thread tension».
 > To increase the upper thread tension, slide the slider upwards or touch the icon «+».
 > To decrease the upper thread tension, slide the slider downwards or touch the icon «-».

Adjusting the maximum embroidering speed

You can use this function to reduce the maximum speed.



> Touch the icon «Home».



> Touch the icon «Setup Program».



> Touch the icon «Embroidery settings».



> Touch the icon «Change maximum speed».
 > To decrease the embroidery speed, slide the slider to the left or touch the icon «-».
 > To increase the maximum embroidery speed, slide the slider to the right or touch the icon «+».

Setting the embroidery motif position when opening

As the default setting, opened embroidery motifs are always displayed in the center of the hoop. You can use the switch «Restore saved embroidery motif position» to set that embroidery motifs are opened at the position in the hoop at which they had been saved in the BERNINA stitch software.



> Tap «Home».



> Touch the icon «Setup Program».



> Touch the icon «Embroidery settings».



> Touch the icon «Center the embroidery motif».



> To open the embroidery motif at the saved position, set the switch «Restore saved embroidery motif position» to «I».
 > To open the embroidery motif in the center of the hoop, set the switch «Restore saved embroidery motif position» to «0I».

Calibrating the hoop

The calibration of the embroidery hoop is the coordination of the needle to the center of the embroidery hoop.

Prerequisite:

- The embroidery module is connected.
- The hoop is fitted with the corresponding embroidery pattern.



> Touch the icon «Home».



> Touch the icon «Setup Program».



> Touch the icon «Embroidery settings».



> Touch the icon «Calibrating the hoop».
> Use the arrow icons on the display to move the needle precisely to the center of the pattern.



> Accept the needle position using the icon «Confirm».

Entering the fabric thickness

If the fabric thickness, as for e.g. toweling is more than 4 mm (0.15 inch) it is recommended to select 7.5 mm (0.29 inch) or 10 mm (0.39 inch). The thicker the fabric, the slower the embroidery speed of the machine. When the machine is switched off, the alterations are reset to the default setting 4 mm (0.15 inch).



> Touch the icon «Home».



> Touch the icon «Setup Program».



> Touch the icon «Embroidery settings».



> Touch the icon «Select fabric thickness».
> Select fabric thickness.

Programming securing stitches (Smart Secure)

Embroidery motifs are programmed with or without securing stitches. The machine detects if no securing stitches are programmed and adds these.



> Touch the icon «Home».



> Touch the icon «Setup Program».



> Touch the icon «Embroidery settings».



> Touch the icon «Securing stitches on/off».







- > To switch off securing stitches at the start, move the switch in the upper right-hand area to «0».
 - If the embroidery motif has programmed securing stitches, they will be embroidered.
 - If the embroidery motif doesn't have any programmed securing stitches, none are embroidered.
- > To switch on securing stitches at the start, move the switch in the upper right-hand area to «I».
 - If the embroidery motif has programmed securing stitches, they will be embroidered.
 - If the embroidery motif doesn't have any programmed securing stitches, the securing stitches are added and will be embroidered.
- > To switch off securing stitches at the end, move the switch in the lower right-hand area to «0».
 - If the embroidery motif has programmed securing stitches, they will be embroidered.
 - If the embroidery motif doesn't have any programmed securing stitches, none are embroidered.
- > To switch on securing stitches at the end, move the switch in the lower right-hand area to «I».
 - If the embroidery motif has programmed securing stitches, they will be embroidered.
 - If the embroidery motif doesn't have any programmed securing stitches, the securing stitches are added and will be embroidered.

Adjusting the thread cut

The settings for the thread cut can be customized. Deactivate the thread cut after a color change (1) or adjust the length of the connecting stitch (3). The machine does the cutting of the connecting threads at the determined length for you. First, set the length from which the connecting stitches are cut, and then select the embroidery motif.



The length of the connecting thread can be adjusted between 1 mm and 15 mm, the default setting is 6 mm. This means that all connecting stitches longer than 6 mm are cut automatically. If the value is reduced to 1 mm, more thread cuts are carried out, it takes longer to embroider and more loose thread ends can be seen on the wrong side of the fabric. On the right side of the fabric there will be practically none or merely very short connecting stitches which results in a wonderful stitch formation. Reducing the length of the thread cut to 1 mm is particularly of advantage when embroidering texts where usually many short connecting threads occur. As for other embroidery motifs (specifically when both sides of the embroidery motifs are visible) it may be reasonable to not reduce the length of the thread cut so much so that there won't be too many loose thread ends on the wrong side of the fabric. Loose ends get sewn over and can hardly be removed afterwards.





-  > Touch the icon «Home».
-  > Touch the icon «Setup Program».
-  > Touch the icon «Embroidery settings».
-  > Touch the icon «Thread cut settings».



-  > Touch the switch in the upper portion of the display (1) to deactivate the automatic thread cut before the thread is changed.
- > Touch the switch in the upper portion of the display (1) again to activate the automatic thread cut before the thread is changed.
- > Touch the switch in the middle section of the display (2) again and the machine won't stop for a manual thread cut.
- > Touch the switch in the middle section of the display (2) again so that the machine will stop after about 7 stitches and the remaining thread can be cut manually.
- > Touch the icons «-» or «+» (3) to adjust the length from where the connecting stitches are cut.

Changing the measuring unit

The unit of measurement in the embroidery mode can be changed from mm to inches. The default setting is mm.

-  > Touch the icon «Home».
-  > Touch the icon «Setup Program».
-  > Touch the icon «Embroidery settings».
-  > Touch the icon «Change measuring unit».
- > To change the unit of measurement in embroidery mode to inches, touch the icon «Inch» (1).

- > To change the unit of measurement in embroidery mode to mm, touch the icon «mm» (2).



3.3 Selecting personal settings



- > Touch the icon «Home».



- > Touch the icon «Setup Program».



- > Touch the icon «Own settings».



- > Select the required display color and background.
- > To change the welcome message, touch the text field above the color settings.
- > Enter the welcome message.
- > For upper-case letters, touch the icon «ABC» (default setting).
- > For lower-case letters, touch the icon «abc».
- > For numbers and mathematical symbols, touch the icon «123».
- > For special characters, touch the icon «@&!».
- > To completely delete the text, touch inside the text field above the keyboard.
- > To delete individual letters, touch the icon «DEL».



- > To accept the text, touch the icon «Confirm».



- > Close the window.



- > Touch the icon «Home».
 - The welcome message is saved.

3.6 Machine settings

Selecting a language



> Tap «Home».



> Tap «Setup Program».



> Tap «Machine settings».



> Tap «Language selection».
> Tap the required language.

Adjusting the brightness of the display

The brightness of the display can be set to meet your individual needs.



> Touch the icon «Home».



> Touch the icon «Setup Program».



> Touch the icon «Machine settings».



> Touch the icon «Adjust brightness».
> To change the display brightness, slide the slider in the upper area of the display to the left or right, or touch the icons «+» or «-».

Adjusting the sewing light

You can set the brightness of the sewing light to meet your individual needs.



> Touch the icon «Home».



> Touch the icon «Setup Program».



> Touch the icon «Machine settings».



> Touch the icon «Adjust brightness».

- > To switch off the sewing light, move the switch to «0».
- > To switch on the sewing light, move the switch to «I».
- > To set the brightness of the sewing light, slide the slider in the lower area of the display to the left or right, or touch the icons «+» or «-».

Checking the firmware version

The machine's firmware and hardware versions are displayed.



- > Touch the icon «Home».



- > Touch the icon «Setup Program».



- > Touch the icon «Machine settings».



- > Touch the icon «Information».



- > Touch the icon «Firmware and Hardware Information».

Reviewing the total number of stitches

The total number of stitches of the machine as well as the number of stitches since the last service carried out by the specialized BERNINA dealer are displayed.



- > Touch the icon «Home».



- > Touch the icon «Setup Program».



- > Touch the icon «Machine settings».



- > Touch the icon «Information».



- > Touch the icon «Firmware and Hardware Information».

Registering details of the dealer

The contact details for your specialized BERNINA dealer can be entered.

Setup Program



> Touch the icon «Home».



> Touch the icon «Setup Program».



> Touch the icon «Machine settings».



> Touch the icon «Information».



> To enter the dealer details, touch the icon «Dealer data».



> To enter the company name of the specialized BERNINA dealer, touch the icon «Company name».



> To enter the address of the specialized BERNINA dealer, touch the icon «Address».



> To enter the telephone number for the specialized BERNINA dealer, touch the icon «Telephone».



> To enter the website or e-mail address for the specialized BERNINA dealer, touch the icon «Internet».

Saving Service data

The service data regarding the current status of the machine can be saved on the BERNINA USB stick (optional accessory) and provided to the specialized BERNINA dealer.

> Insert the BERNINA USB stick (optional accessory) with enough free capacity into the machine's USB slot.

> Touch the icon «Home».



> Touch the icon «Setup Program».



> Touch the icon «Machine settings».



> Touch the icon «Information».



- > Touch the icon «Service data».
- > Touch the icon «LOG».
 - The icon "LOG" has a white frame.
- > Ensure that the white frame is no longer displayed and remove the BERNINA USB stick (optional accessory).

Back to basic setting

ATTENTION: Using this function will delete all individually made settings.



- > Touch the icon «Home».



- > Touch the icon «Setup Program».



- > Touch the icon «Machine settings».



- > Touch the icon «Default settings».



- > Touch the icon «Default setting sewing».



- > Touch the icon «Confirm» to restore the default settings for the sewing settings.



- > Touch the icon «Default setting embroidery».



- > Touch the icon «Confirm» to restore the default settings for the embroidery settings.



- > Touch the icon «Default setting all».



- > Touch the icon «Confirm» and restart the machine to restore all default settings.

Deleting user data

Motifs which are not needed anymore can be deleted so that there will be more capacity for new motifs.



- > Touch the icon «Home».



- > Touch the icon «Setup Program».





- > Touch the icon «Machine settings».



- > Touch the icon «Default settings».



- > Touch the icon «Delete data from the personal memory».

-  > Touch the icon «Confirm» to delete all data from the personal memory.
-  > Touch the icon «Delete personal embroidery motifs».
-  > Touch the icon «Confirm» to delete all embroidery motifs from the personal memory.

Deleting motifs on the BERNINA USB Stick

When motifs which won't be needed anymore are saved on the BERNINA USB Stick (Optional accessory), the stick can be connected to the machine and the data can be deleted.

- > Insert the BERNINA USB Stick (Optional accessory) into the den USB port of the machine.
- > Touch the icon «Home».



- > Touch the icon «Setup Program».



- > Touch the icon «Machine settings».



- > Touch the icon «Default settings».



- > Touch the icon «Delete data from USB Stick».



- > Touch the icon «Confirm» to delete all data on the BERNINA USB Stick (optional accessory).



Calibrating the Buttonhole foot No. 3A

The Buttonhole foot with slide No. 3A and the machine are synchronized with each other and should only be used together.

Prerequisite:

- The Buttonhole foot No. 3A is attached.
- The needle is not threaded.

- > Touch the icon «Home».



- > Touch the icon «Setup Program».



- > Touch the icon «Machine settings».



- > Touch the icon «Maintenance/Update».





- > Touch the icon «Calibrate the Buttonhole foot No. 3A».
- > Lower the Buttonhole foot with slide No. 3A.



- > To start the calibration, touch the button «Start/Stop».



- > After the calibration is finished, close the window.

Updating the machine Firmware

The machine's current firmware and detailed step-by-step instructions for the update process can be downloaded from www.bernina.com. In general, personal data and settings are automatically transferred during a firmware update. For reasons of safety, it is also recommended to save data and settings on a BERNINA USB stick (optional accessory) before the firmware update is started. If personal data and settings should get lost during a firmware update, they can be transferred to the machine again afterwards.

NOTICE

The BERNINA USB stick (optional accessory) has been removed too early

Firmware has not been updated and the machine cannot be used.

- > Remove the BERNINA USB stick (optional accessory) only after the update has been completed successfully.

- > Insert the BERNINA USB stick (optional accessory), FAT32 formatted, providing the latest software into the port.



- > Touch the icon «Home».



- > Touch the icon «Setup Program».



- > Touch the icon «Machine settings».



- > Touch the icon «Maintenance/Update».



- > Touch the icon «Update the machine».



- > Touch the icon «Save data on USB stick».
- The icon is checkmarked in green.



- > To start the firmware update, touch the icon «Update».

Recovering saved data

If personal data and settings after a software update are not available anymore, they can be transferred to the machine again afterwards.

NOTICE

The BERNINA USB stick (optional accessory) has been removed too early

Saved data cannot be transferred and the machine cannot be used.

> Remove the BERNINA USB stick (optional accessory) only after the saved data has been transferred successfully.

> Insert the BERNINA USB stick (optional accessory) providing the saved data and settings into the USB port of the machine.

> Touch the icon «Home».



> Touch the icon «Setup Program».



> Touch the icon «Machine settings».



> Touch the icon «Maintenance/Update».



> Touch the icon «Update the machine».



> Touch the icon «Transfer saved data to machine».
– The icon is checkmarked in green.



Cleaning the thread catcher

The chapter «Maintenance and cleaning» provides additional illustrated step-by-step instructions for this.

> Touch the icon «Home».



> Touch the icon «Setup Program».



> Touch the icon «Machine settings».



> Touch the icon «Maintenance/Update».



> Touch the icon «Clean thread catcher».

> Clean the thread catcher according to the instructions on the display.



Packing the embroidery module

To pack the embroidery module into the original packaging without moving the embroidery arm manually, the embroidery arm needs to be brought to its packing position.

Prerequisite:

- The embroidery module is connected with the machine.



> Touch the icon «Home».



> Touch the icon «Setup Program».



> Touch the icon «Machine settings».



> Touch the icon «Maintenance/Update».



> Touch the icon «Packing position for embroidery module».
> Follow the instructions on the display.



4 System settings

4.1 Calling up the Tutorial

The Tutorial gives information and explanations, covering various aspects of sewing, embroidering and the different stitches.



- > Touch the icon «Home».



- > Touch the icon «Tutorial».
- > Select the desired topic to get information.

4.2 Calling up the Creative Consultant

The Creative Consultant informs you about decision support for sewing projects. After entering the kind of fabric and the desired sewing project, suggestions concerning the suitable needle or the appropriate presser foot are displayed.



- > Touch the icon «Home».



- > Touch the icon «Creative Consultant».
- > Select the fabric on which you want to sew.
- > Select the sewing project.

4.3 Using eco mode

For a longer work stoppage, the machine can be put into energy-saving mode.



- > Touch the icon «Home».



- > Touch the icon «eco mode».
 - The display goes to sleep. The power consumption is reduced and the sewing light is off.
- > To exit energy-saving mode, touch the eco symbol on the display.
 - The machine is ready for use.

4.4 Calling up the Help



- > Touch the window in the display where help is needed.
- > Touch the icon «Help» to start the help mode.
- > Touch the icon in the display where help is needed.
 - Assistance concerning the selected icon is displayed.

4.5 Cancelling any alterations with «clr»

Any alterations to motifs can be reset to default setting. Exceptions are saved motifs which have been filed in the personal memory and monitoring functions.



- > Touch the icon «clr».

5 Creative sewing

5.1 Overview selection menu sewing

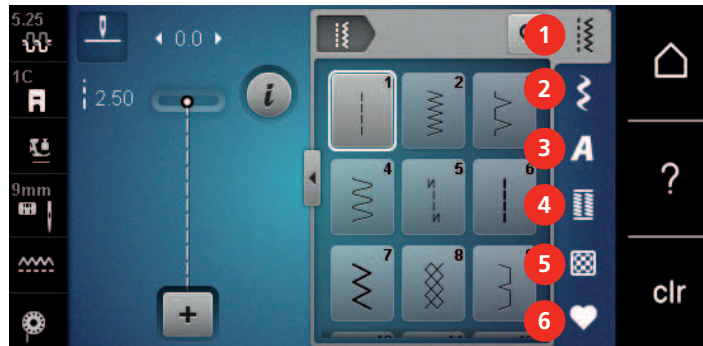

- | | | | |
|---|---------------------|---|-----------------|
| 1 | Practical stitches | 4 | Buttonholes |
| 2 | Decorative stitches | 5 | Quilt stitches |
| 3 | Alphabets | 6 | Personal Memory |

Selecting a stitch pattern

- > Select a stitch pattern, alphabet or buttonhole.
- > With the touchscreen pen/finger scroll up within the range of the practical stitches, alphabets or buttonholes to have more stitch patterns displayed.
- > Touch the icon «Display all the stitch patterns» (1) to scale up the view.
- > Touch the icon «Display all the stitch patterns» (1) again to downsize the stitch pattern view.

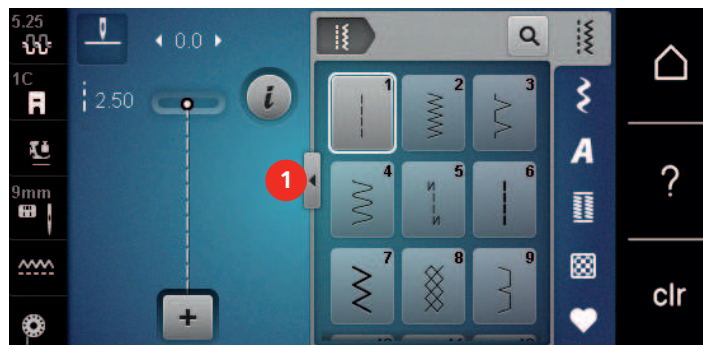

- > Touch the icon «Stitch pattern number entry» to select the stitch pattern via entering the stitch number.

5.2 Regulating the speed

The sewing speed can be adjusted infinitely variable with the slide.

- > Move the slide to the left to reduce the sewing speed.
- > Move the slide to the right to increase the sewing speed.

5.3 Adjusting the upper thread tension

The basic setting of the upper thread tension is provided automatically as soon as a stitch pattern or an embroidery motif is selected.

The upper thread tension is set optimally at the BERNINA factory and the machine has been tested. Metrosene-/Seralon thread size 100/2 (Company Mettler, Switzerland) is used for upper and bobbin thread.

When of using other types of sewing threads, the optimal upper thread tension may vary. Therefore it may be necessary to adjust the upper thread tension individually according to the sewing project as well as the desired stitch pattern.

The higher the upper thread tension, the tighter the upper thread which means that the bobbin thread is pulled up to the top of the fabric. When the upper thread tension is low, the upper thread is less tightened which means that the bobbin thread is pulled up less.

Alterations of the upper thread tension affect the currently selected stitch pattern or embroidery motif. Permanent alterations of the upper thread tension for the sewing mode (see page 47) can be made in the Setup Program.

Prerequisite:

- In the Setup Program the upper thread tension has been altered.
- > Touch the icon «Upper thread tension».
- > Move the slide using the touchscreen pen/finger to increase or reduce the upper thread tension.



- > Touch the yellow-framed icon on the right side to reset the alteration to default setting.
- > Touch the yellow-framed icon on the left side to reset the alteration to default setting in the **Setup Program**.

5.4 Editing stitch patterns

Changing the stitch width

- > Turn the «Upper Multifunction knob» to the left to narrow the stitch width.
- > Turn the «Upper Multifunction knob» to the right to widen the stitch width.
- > To call up further setting options, touch the icon «Stitch width» (1).



Changing the stitch length

- > Turn the «Lower Multifunction knob» to the left to shorten the stitch length.
- > Turn the «Lower Multifunction knob» to the right to elongate the stitch length.

- > To call up further setting options, touch the icon «Stitch length» (1).

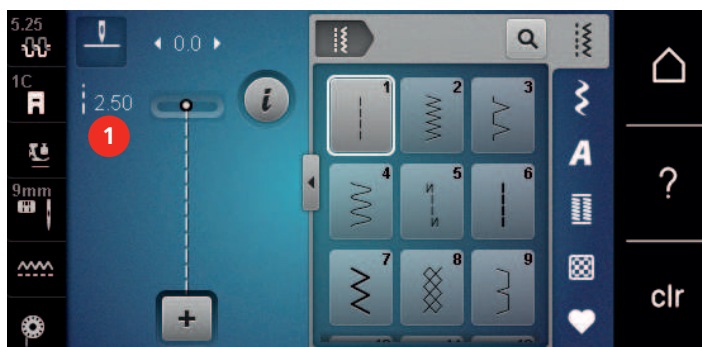

Correcting the balance

Different fabrics, threads and stabilizers can affect the programmed stitch patterns so that they cannot be sewn out correctly. The electronic balance can correct these deviation and the stitch pattern can be adjusted optimally to the selected fabric.

- > Select a stitch pattern or alphabet.
- > Sewing stitch pattern.
- > Touch the icon «i»-Dialog.



- > Touch the icon «Confirm».
- A preview of the stitch pattern is displayed.



- > To correct the longitudinal direction of the stitch pattern, turn the «Lower Multifunction knob» until the preview of the stitch pattern matches the stitch pattern sewn on the fabric.
- > Altered balance settings can be saved for each stitch in the «Personal memory».
- > Altered balance settings only remain valid until the «clr button» is pressed or the machine is switched off.

Programming pattern repeat

Stitch patterns can be repeated up to nine times.

- > Select a stitch pattern or alphabet.
- > Touch the icon «i»-Dialog.



- > To repeat the stitch pattern, touch the icon «Repeat pattern» once.
- > To repeat the stitch pattern up to nine times, touch the icon «Repeat pattern» repeatedly.
- > To switch off the stitch pattern repetition, touch and hold the icon «Repeat pattern» or touch the icon «clr».

Mirror image of stitch patterns



- > Select a stitch pattern or alphabet.
- > Touch the icon «i»-Dialog.



- > Touch the icon «Mirror image left/right» to mirror the stitch pattern from left to right.



- > Touch the icon «Mirror image up/down» to mirror the stitch pattern contrary to the sewing direction.

Quick reverse

- > Select a stitch pattern, alphabet or buttonhole.
- > Program needle stop down (permanent) to switch immediately to Quick reverse as soon as the button «Quick reverse» is pressed.
- > Program needle stop up (permanent) to sew another stitch forward before the machine switches to reverse sewing.

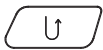

- > Push the button «Quick reverse» and keep pressed.

Permanent Quick reverse



- > Select a stitch pattern or alphabet.
- > Touch the icon «i»-Dialog.

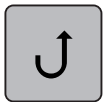

- > Touch the icon «Permanent reverse sewing» to sew permanently in reverse.
 - The machine keeps sewing in reverse until the icon «Permanent reverse sewing» is touched again.

Backstepping



- > Select a stitch pattern or alphabet.
- > Touch the icon «i»-Dialog.



- > Touch the icon «Backstepping» to backstep the last 200 stitches.

5.5 Combining stitch patterns

Overview Combi mode

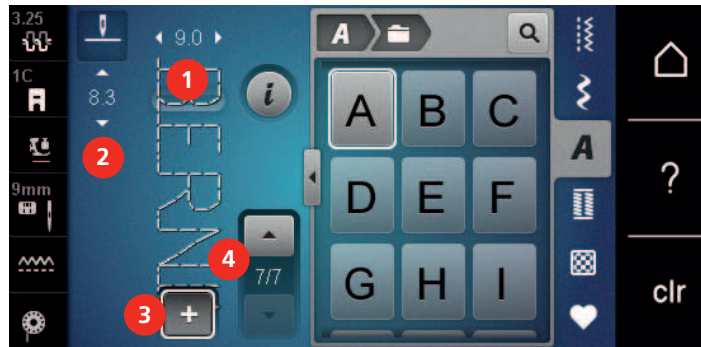

- | | | | |
|---|--|---|--|
| 1 | Stitch width of the active stitch pattern | 3 | Combination mode/single mode |
| 2 | Stitch length of the active stitch pattern | 4 | Individual stitch pattern within the combination |

Creating Stitch pattern combinations

In the Combi mode stitch patterns and alphabets can be combined according to your wish. By combining any alphabet letters, the logo BERNINA can be created.



- > Touch the icon «Single/Combi mode».
- > Select the desired stitch patterns.



- > Touch the icon «Single/Combi mode» again to return to the single mode.

Saving a stitch pattern combination

To be able to use individually created stitch pattern combinations, they can be saved in «Personal Memory».

- > Create a stitch pattern combination.
- > Touch the icon «Personal memory».





- > Touch the icon «Save stitch pattern».





- > Touch the icon «Confirm» or the yellow-framed icon to save the stitch pattern combination.





Loading a stitch pattern combination

-  > Touch the icon «Single/Combi mode».
-  > Touch the icon «Personal memory».
-  > > Touch the icon «Selection of stitch pattern combination».
- > Select a stitch pattern combination.

Overwriting a stitch pattern combination

- > Create a stitch pattern combination.
- > Touch the icon «Personal memory».
-  > Touch the icon «Personal memory».
-  > Touch the icon «Save stitch pattern».
- > Select the stitch pattern combination which is to be overwritten.
-  > Touch the icon «Confirm» to overwrite the stitch pattern combination.

Deleting a stitch pattern combination

- > Create a stitch pattern combination.
- > Touch the icon «i»-Dialog.
-  > Touch the icon «i»-Dialog.
-  > Touch the icon «Edit the whole combination».
-  > Touch the icon «Delete».
-  > Touch the icon «Confirm».

Editing a single stitch pattern

- > Create a stitch pattern combination.
- > With the touchscreen pen/finger touch the desired position (1) within the stitch pattern combination to select a single stitch pattern.

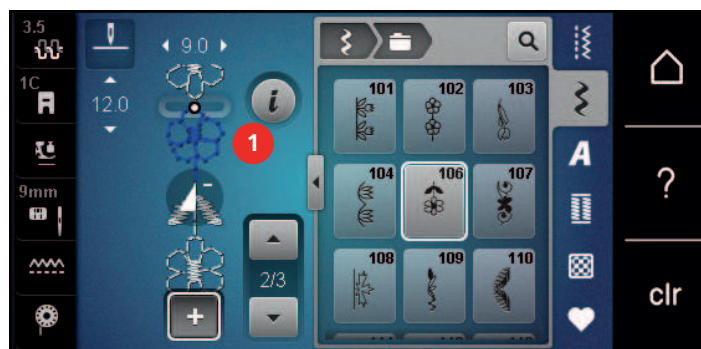



- > Touch the icon «i»-Dialog to edit the single stitch pattern.

Deleting a single stitch pattern

- > Create a stitch pattern combination.
- > Use the touchscreen pen/your finger to touch the required position (1) in the stitch pattern combination in order to select an individual stitch pattern.

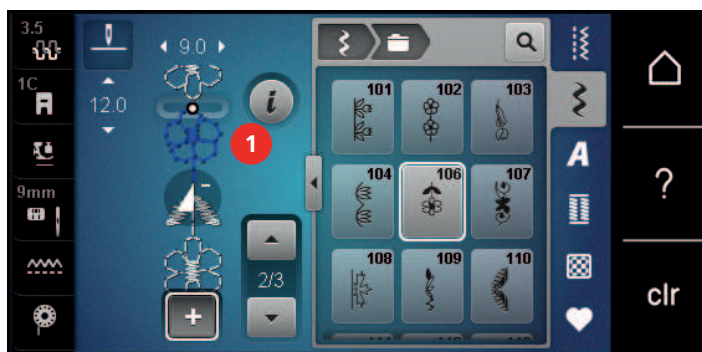

- > Touch the icon «i»-Dialog.



- > Touch the icon «Delete» to delete the individual stitch pattern.

or

- > Use the touchscreen pen/your finger to touch the required stitch pattern (1) in the stitch pattern combination, hold this down and slide the stitch pattern outwards.
 - The stitch pattern is deleted.

Adding a single stitch pattern

The new stitch pattern is always inserted **after** the selected stitch pattern.

- > Create a stitch pattern combination.
- > With the touchscreen pen/finger touch the desired position (1) within the stitch pattern combination to select a single stitch pattern.

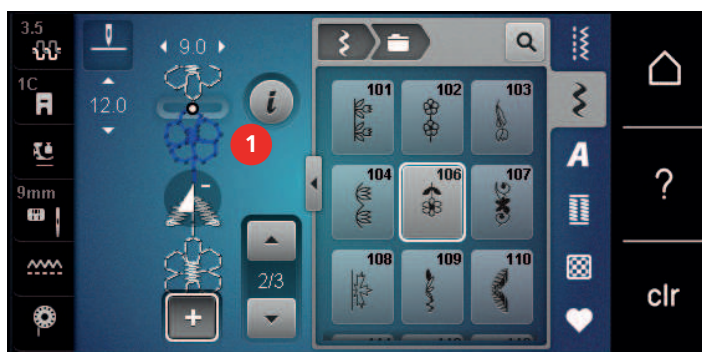

- > Select a new stitch pattern.

Mirroring a stitch pattern combination

- > Create a stitch pattern combination.





- > Touch the icon «i»-Dialog.



- > Touch the icon «Edit the whole combination».



- > Touch the icon «Mirror image left/right» to mirror the whole stitch pattern combination from the left to the right.
- > Touch the icon «Mirror image left/right» again to reset the alterations to default setting.

Stitch pattern combination Subdivider 1

A stitch pattern combination can be subdivided into several sections. The subdivision is placed **beneath** the cursor. Only this section is sewn where the cursor is placed. To sew the next section, the cursor must be placed in the next section.

- > Create a stitch pattern combination.
- > With the touchscreen pen/finger select the desired position within the stitch pattern combination where the stitch pattern combination is to be subdivided.
- > Touch the icon «i»-Dialog.

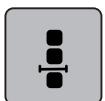

- > Touch the icon «Edit combination at cursor position».

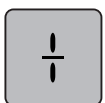

- > Touch the icon «Combination subdivider».

Stitch pattern combination Subdivider 2

A stitch pattern combination can be interrupted at several positions. The interruption is placed **beneath** the cursor.

- > Create a stitch pattern combination.
- > With the touchscreen pen/finger select the desired position within the stitch pattern combination where the stitch pattern combination is to be interrupted.
- > Touch the icon «i»-Dialog.

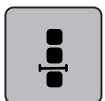

- > Touch the icon «Edit combination at cursor position».

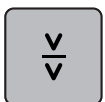

- > Touch the icon «Combination subdivider 2».
- > Sew the first section and then reposition the fabric.

Securing a stitch pattern combination

- > Create a stitch pattern combination.
- > With the touchscreen pen/finger select the desired position within the stitch pattern combination where the stitch pattern combination is to be secured.



> Touch the icon «i»-Dialog.

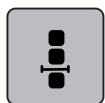

> Touch the icon «Edit combination at cursor position».



> Touch the icon «Securing».
– Every single pattern of the stitch pattern combination can be secured at the start or at the end.

Programming pattern repeat



> Create a stitch pattern combination.
> Touch the icon «i»-Dialog.

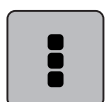

> Touch the icon «Edit the complete combination».



> Touch the icon «Pattern repeat» once to repeat the stitch pattern combination.
> Touch the icon «Pattern repeat» again to repeat the stitch pattern combination up to 9 times.
> To deactivate the pattern repeat, keep the icon «Pattern repeat» pressed or touch the icon «clr».

5.6 Administering stitch patterns

Saving settings of stitch patterns



> Select a stitch pattern, alphabet or buttonhole.
> Touch the icon «i»-Dialog.
> Edit the stitch, alphabet or buttonhole.



> Touch the icon «Saving stitch pattern settings» to save the alterations permanently.



> Touch the icon «Back to default setting» to cancel the alterations.

Saving stitch patterns in personal memory

In the filing system «Personal memory» any stitch patterns, also those which have been individually edited, can be saved.

> Select a stitch pattern, alphabet or buttonhole.
> Edit the stitch pattern.
> Touch the icon «Personal memory».



> Touch the icon «Save stitch pattern».
> Select the file where the pattern is to be saved.



> Touch the icon «Confirm».

Uploading a stitch pattern from the BERNINA USB stick



- > Touch the icon «Personal memory».



- > Touch the icon «Load stitch pattern».
- > Touch the icon (1).

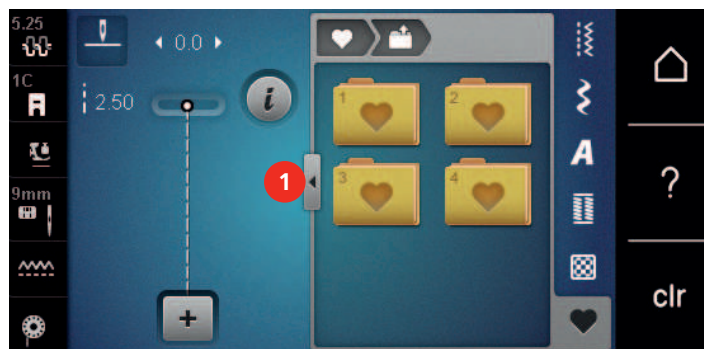

- > Insert the BERNINA USB stick into the USB port of the machine.
- > Touch the icon «USB stick».
- > Select the desired stitch pattern.

Deleting stitch patterns from the BERNINA USB stick



- > Touch the icon «Personal memory».



- > Touch the icon «Delete».
- > Insert the BERNINA USB stick into the USB port of the machine.
- > Select the stitch pattern which is to be deleted.



- > Touch the icon «Confirm».

5.7 Securing

Securing a seam with the button «Securing»

The button «Securing» can be programmed with various securing stitches.



- > Push the button «Securing» before starting to sew.
 - The stitch pattern/stitch pattern combination will be secured with the number of programmed stitches when sewing is started.
- > Push the button «Securing» while sewing.
 - The machine stops immediately and secures with the number of programmed stitches.

5.9 Sewing Corners

When sewing corners, only a small section of the fabric is actually on the feed dog. Therefore it cannot grip the fabric well. By means of the height compensation tool the fabric can be fed evenly.

- > When the fabric edge is reached, stop the sewing process with needle position down.
- > Raise the presser foot.
- > Turn the fabric and place in desired position.
- > Place 1 – 3 compensating plates as required on the right of the presser foot close to the sewing project.
- > Lower the presser foot.

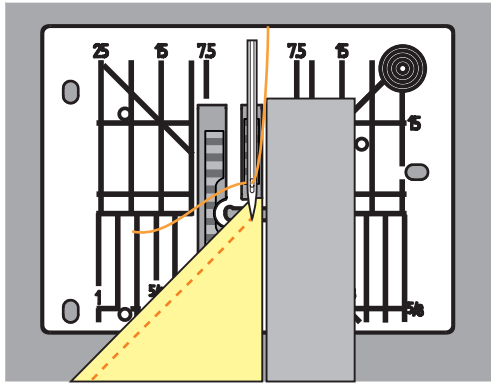







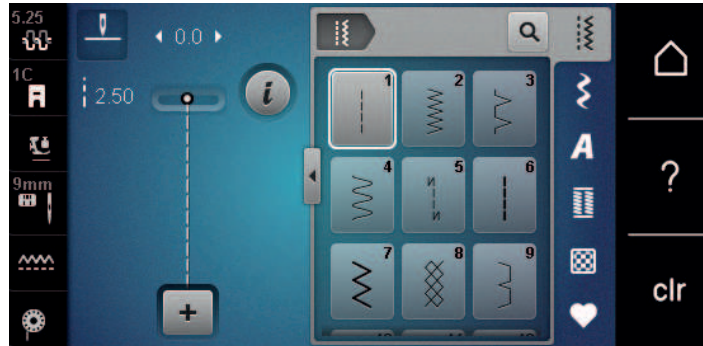



















- > Resume sewing until the sewing project is on the feed dog again.

6 Practical stitches

6.1 Overview Practical stitches



Stitch patterns	Stitch number	Name	Description
	1	Straight stitch	Seams and topstitching.
	2	Zig zag	Reinforcing seams, finishing edges, sewing elastic seams and attaching lace.
	3	Vari overlock	Sewing and finishing elastic fabrics in one step.
	4	Running stitch	Darning with running stitch, mending fabrics, reinforcing edges.
	5	Securing Program	Securing starts and ends of seams by straight stitching.
	6	Triple Straight stitch	For durable seams in heavy fabrics; visible hems and seams.
	7	Triple Zig zag	For durable seams in heavy fabrics; visible hems and seams.
	8	Honeycomb stitch	For elastic fabrics and hems. Is also used with elastic bobbin threads.
	9	Blind stitch	Blind hems, shell edging effect on soft jerseys and fine material, decorative seams.
	10	Double overlock	Sewing and finishing in one step of elastic fabrics.
	11	Superstretch stitch	For highly stretch fabrics. For all types of clothing.

Stitch patterns	Stitch number	Name	Description
	12	Gathering stitch	Most types of fabrics; gathering with shirring elastic, butted seams = butting two pressed edges and sewing together, decorative stitches.
	13	Stretch overlock	Sewing and finishing elastic fabrics in one step.
	14	Tricot stitch	Visible hems, visible seams in lingerie, sweaters, mending jersey.
	15	Universal stitch	For firm fabrics such as felt and leather. Flat joining seams, visible seams, attaching elastic, decorative seams.
	16	Sewn-out Zig zag	Edge finishing and reinforcing, attaching elastic, decorative seam.
	17	Lycra stitch	For lycra fabrics; flat joining seams and hems, reinforced seaming on underwear.
	18	Stretch stitch	For highly stretch fabrics; open seam for sportswear.
	19	Reinforced overlock	For medium-weight knitware and toweling; overlock seams, flat joining seams.
	20	Knit overlock	Sewing and finishing in one step of hand and machine knitted fabrics.
	22	Simple Darning Program	Darning holes and damaged fabric.
	23	Reinforced Darning Program	Reinforcing darned holes and damaged fabric.
	24	Bartack Program	Reinforcing pocket openings, sewing belt loops.
	25	Bartack Program	Reinforcing pocket openings, sewing on belt loops, securing zippers and seam ends.
	26	Large Fly stitch	Reinforcing pocket openings, zippers and slits in medium-weight to thick fabrics.
	29	Blindstitch narrow	For blind hems in fine fabrics.
	30	Basting stitch	For basting seams, hems, quilts, etc.



6.3 Securing with the automatic Securing Program

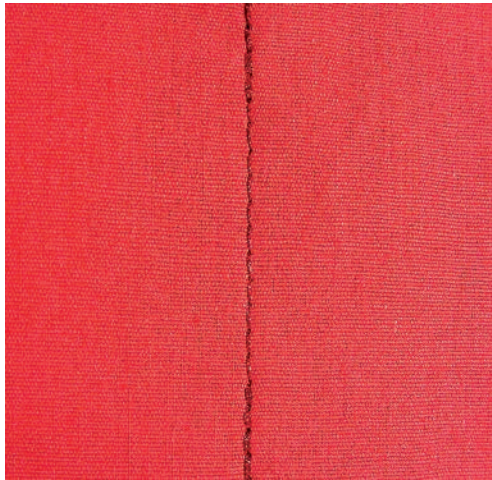

Due to a determined number of 5 stitches sewn forward and 5 stitches sewn backward, the securing is regular.

Prerequisite:

- The Reverse pattern foot No. 1C is attached.



- > Touch the icon «Practical stitches».
- > Select the Securing Program No. 5.
- > Press the foot control.
 - The machine secures automatically.

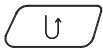

- > Sew the seam in the desired length.
- > Push the button «Quick reverse».
 - The machine secures automatically and stops at the end of the securing program.

6.4 Sewing in the zipper

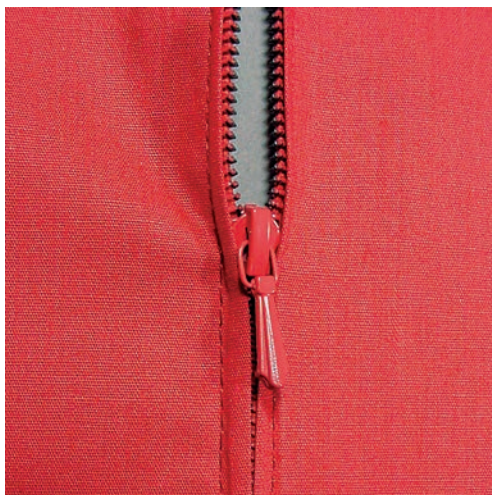

As the fabric feed can be difficult when starting to sew, it is recommended to hold the threads firmly or to pull the fabric slightly to the back for a few stitches or to sew 1 – 2 cm reverse first.

- > Attach the Reverse pattern foot No. 1C.

- > Start sewing in the center of the seam at the end of the zipper.
- > Sew diagonally along the edge of the zipper coils.
- > Sew the first side (1) from bottom to top.
- > Stop in front of the zipper pull with needle position down.
- > Raise the presser foot.
- > Open the zipper as far as behind the presser foot.
- > Lower the presser foot and continue sewing.
- > Move the needle position to the left.
- > Sew the second side (2) in exactly the same way from bottom to top.

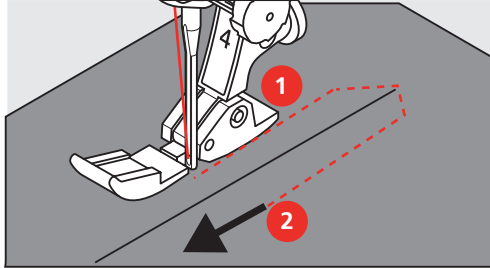

6.6 Sewing triple straight stitch



The triple straight stitch is especially suitable for durable seams and for firm, densely woven fabrics such as denim and corduroy. For firm or densely woven materials, it is recommended to attach the Jeans foot No. 8. This will help to sew denim or canvas. For decorative topstitching, the stitch length can be elongated.

- > Attach the Reverse pattern foot No. 1C.
- > Touch the icon «Practical stitches».
- > Select the Triple straight stitch No. 6.



6.7 Sewing Triple zig zag

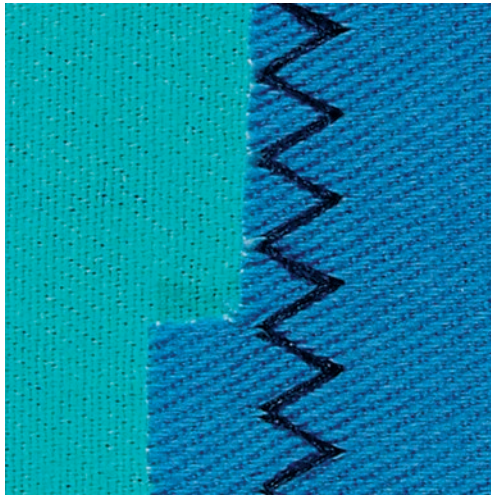

For firm fabrics, especially for denim, deckchair covers, awnings. Hems on items that need frequent washing. Finish the hem edges first.

- > Attach the Reverse pattern foot No. 1C.
- > Touch the icon «Practical stitches».
- > Select the Triple zig zag No. 7.



6.8 Manual darning

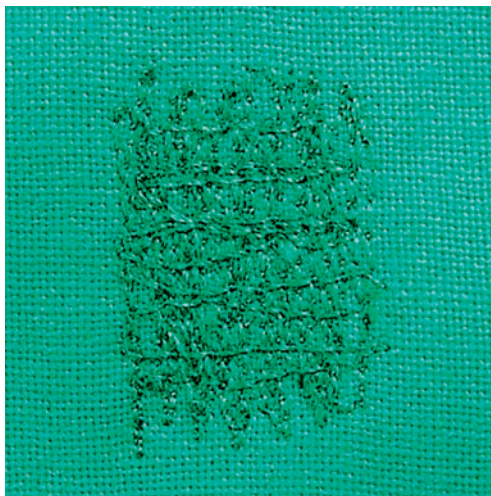

Used for darning holes or worn areas in all fabric types.

If the thread is lying on top and a poor stitch formation results, slow down the movement of the sewing project. If there are knots on the wrong side of the fabric, move the sewing project faster. When the thread breaks, guide the sewing project more consistently.

- > Attach the Darning foot No. 9 (optional accessory).
- > Touch the icon «Practical stitches».
- > Select the Straight stitch No. 1.
- > Lower the feed dog.
- > Attach the slide-on table.
- > Hoop the sewing project in the round embroidery hoop (optional accessory).
 - The area to be darned stays evenly taut and cannot be distorted.
- > Sew from the left to the right, guide the fabric evenly by hand without using pressure.
- > Move in curves when changing the direction to avoid holes and thread breakage.



- > Work the rows in irregular lengths so that the thread is better spread over the fabric.

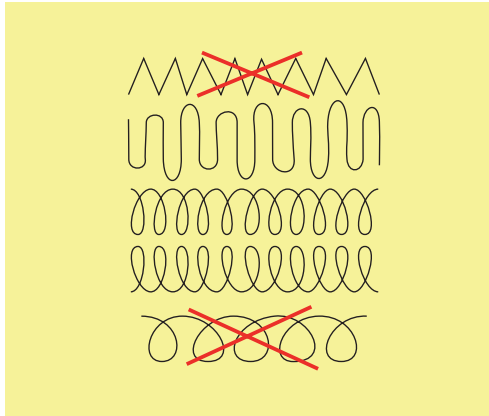

- > Sew the first rows not too close together and beyond the worn area.
- > Sew the rows in irregular lengths.

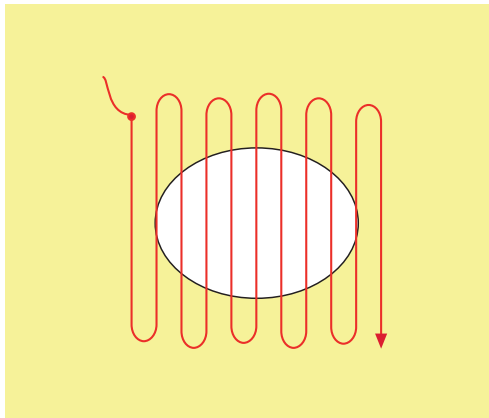

- > Turn the sewing project by 90°.
- > Sew the first rows not too close.

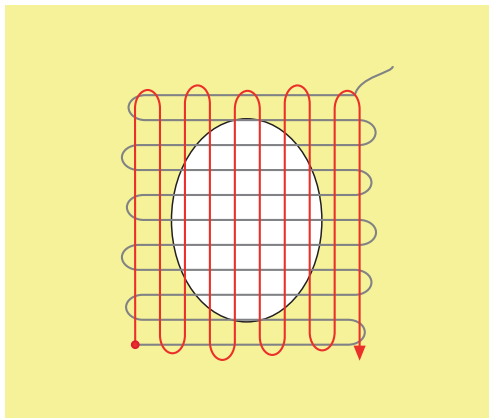

- > Turn the sewing project by 180°.

6.10 Reinforced darning, automatic

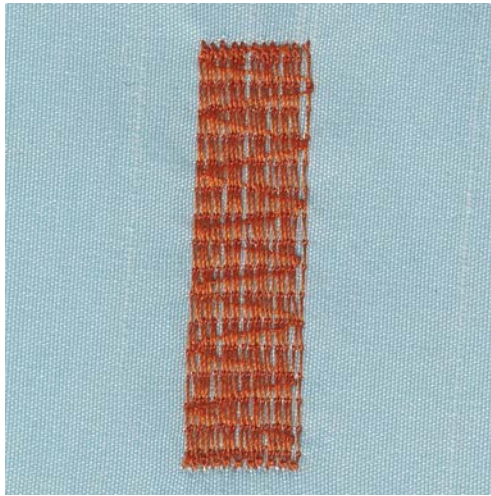

The reinforced Darning Program No. 23 is especially suitable for quick darning of thin areas or snags. The reinforced Darning Program No. 23 replaces longitudinal threads in all fabrics.



If the Darning Program does not cover the whole worn or damaged area, it is recommended to reposition the work and sew the Darning Program again. The length is programmed and can be repeated as often as desired.



- > Attach the Buttonhole foot No. 3A.
- > Touch the icon «Practical stitches».
- > Select the reinforced Darning Program No. 23.
- > Hoop light-weight materials in the round embroidery hoop (optional accessory).
 - The darning area stays evenly taut and cannot be distorted.
- > Start sewing top left.
- > Sew the first row.
- > Stop the machine.



- > Push the button «Quick reverse».
 - The darning length is programmed.
- > Finish sewing the Darning Program.
 - The machine stops automatically.

6.11 Reinforced Darning Program

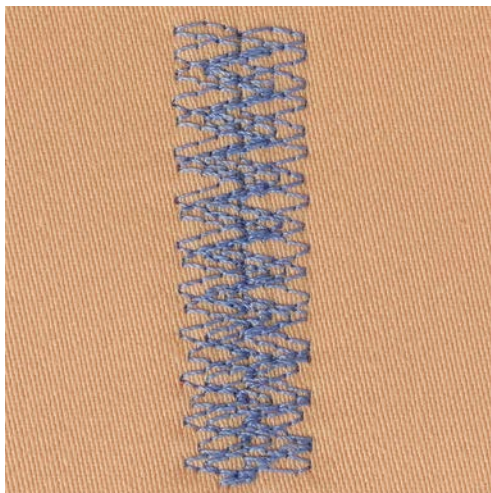

A double overlock seam is suitable for loose knits and cross seams in knits. When working with jersey, a jersey needle should be used to prevent damaging the knit fabric. When sewing stretch materials, use a stretch needle.

- > Attach the Reverse pattern foot No. 1C or the Overlock foot No. 2A.
- > Touch the icon «Practical stitches».
- > Select the Double overlock No. 10.



6.14 Narrow edgestitching

- > Attach the Blindstitch foot No. 5 (optional accessory) or the Reverse pattern foot No. 1C or the Edge stitch foot No. 10/10C (optional accessory).
- > Touch the icon «Practical stitches».
- > Select the Straight stitch No. 1.
- > Place the edge on the left against the guide on the Blindstitch foot.
- > Select the needle position left in the desired distance to the edge.

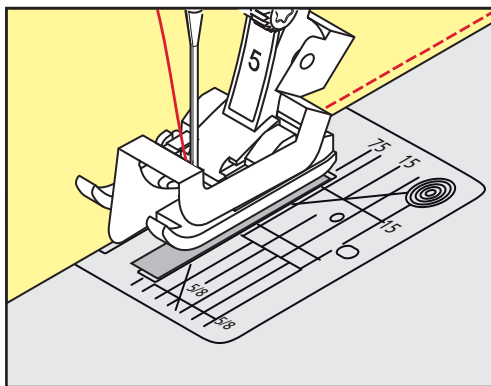

6.15 Wide edgestitching

- > Attach the Blindstitch foot No. 5 (optional accessory) or the Reverse pattern foot No. 1C or the Edge stitch foot No. 10/10C (optional accessory).
- > Touch the icon «Practical stitches».
- > Select the Straight stitch No. 1.
- > Guide the edge along the presser foot or along the marks at a distance of 1 – 2,5 cm (0,39 – 0,98 inch).
- > Select the needle position at the desired distance to the edge.

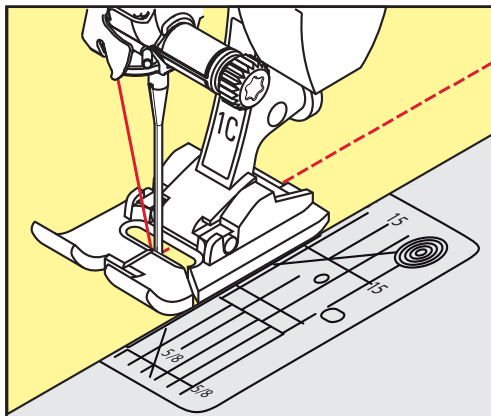

6.16 Edgestitching using the seam guide (optional accessory)

When sewing parallel wider lines, it is recommended to guide the seam guide (optional accessory) along a sewn line.

- > Attach the Reverse pattern foot No. 1C or the Edge stitch foot No. 10/10C (optional accessory).
- > Touch the icon «Practical stitches».
- > Select the Straight stitch No. 1.
- > Loosen the screw on the back of the presser foot.
- > Insert the seam guide into the hole of the presser foot.
- > Adjust the width as desired.
- > Tighten the screw.
- > Guide the folded edge along the seam guide.

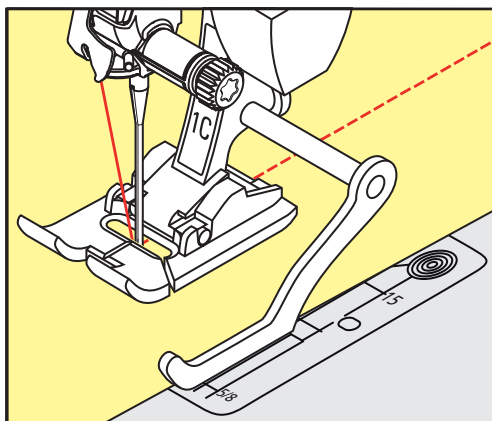

6.17 Sewing hem edges

When using the Blindstitch foot No. 5 (optional accessory), it is recommended to select a needle position far left or far right. When using the Reverse pattern foot No. 1C or the Edge stitch foot No. 10/10C (optional accessory) all needle positions are possible.

- > Attach the Blindstitch foot No. 5 (optional accessory) or the Reverse pattern foot No. 1C or the Edge stitch foot No. 10/10C (optional accessory).
- > Touch the icon «Practical stitches».
- > Select the Straight stitch No. 1.
- > Place the inside upper edge right against the guide of the Blindstitch foot.
- > Select the needle position far right to sew along the upper edge.

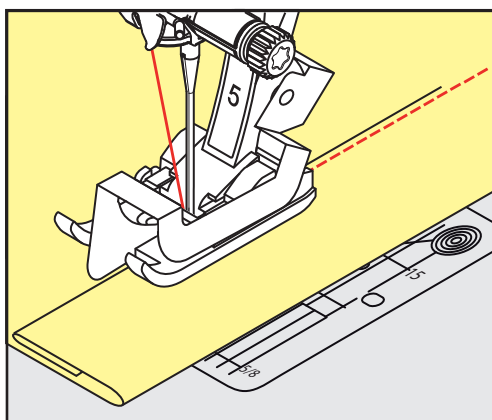

6.18 Sewing blind hems

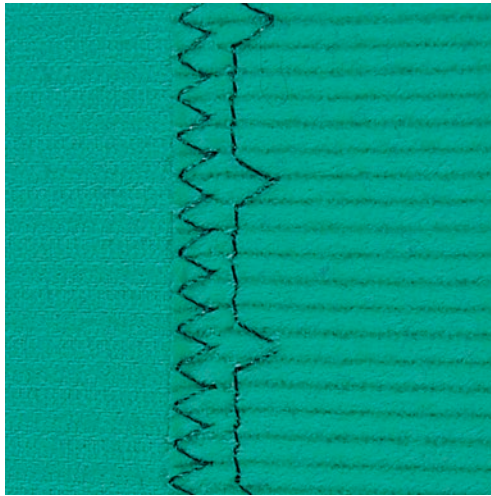

For invisible hems in medium to heavy-weight cotton, wool and blended materials.

Prerequisite:

- The fabric edges are finished.
- > Attach the Blindstitch foot No. 5 (optional accessory).
- > Touch the icon «Practical stitches».
- > Select the Blindstitch No. 9.
- > Fold the fabric back over the right side of the fabric to expose the finished lower edge.
- > Place the fabric under the presser foot and move the folded edge against the metal guide on the presser foot.
- > Guide the folded edge evenly along the metal guide of the foot to sew the stitches evenly deep.
 - Make sure that the needle only pierces the edge of the fold.
- > After sewing about 10 cm (ca. 3.93 inch) check both sides of the fabric and adjust the width again if necessary.

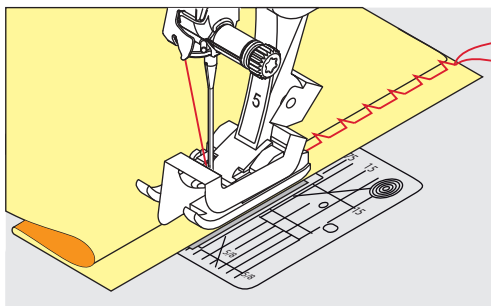

6.19 Sewing visible hems

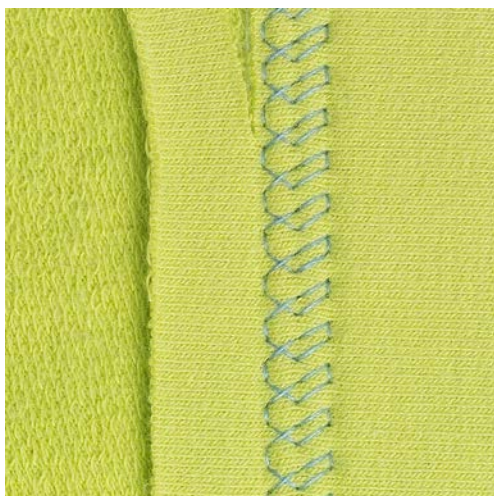

The visible hem is especially suitable for elastic hems in jersey made of cotton, wool, synthetic and mixed fibers.



- > Attach the Reverse pattern foot No. 1C.
- > Touch the icon «Practical stitches».
- > Select the Tricot stitch No. 14.
- > Iron and baste the hem if necessary.
- > Reduce the presser foot pressure if necessary.
- > Sew the hem at the preferred depth on the right side of the fabric.
- > Trim the excess fabric from the wrong side of the fabric.

6.20 Sewing flat joining seams

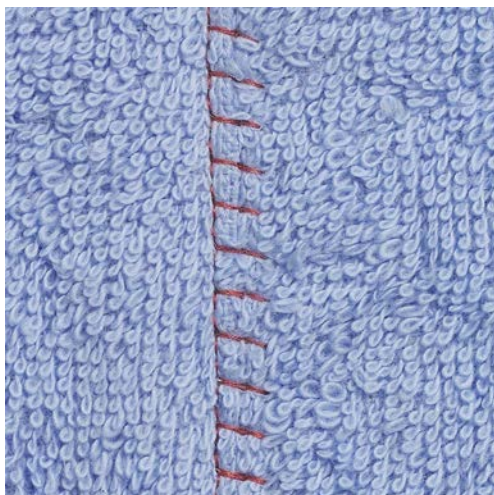

The flat joining seam is especially suitable for or thick materials such as terry cloth, felt and leather.



- > Attach the Reverse pattern foot No. 1C.
- > Touch the icon «Practical stitches».
- > Select the Stretch overlock No. 13.
- > Overlap the fabric edges.
- > Sew along the fabric edge.
- > The needle stitches over the edge of the top layer on the right side into the bottom layer to get a very flat durable seam.

6.21 Sewing basting stitches

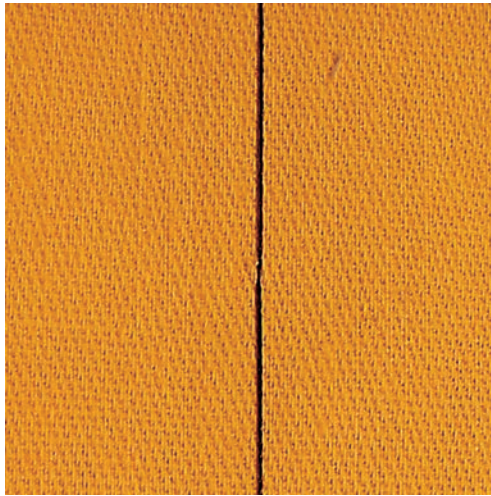

For basting it is recommended to use a thin darning thread. It can be removed easily. The basting stitch is suitable for work where a large stitch length is desired.

- > Attach the Darning foot No. 9 (optional accessory).
- > Lower the feed dog.
- > Touch the icon «Practical stitches».
- > Select the Basting stitch No. 30.
- > Pin the fabric layers at a right angle to basting direction to prevent the layers from slipping.
- > Hold the threads and sew 3 – 4 securing stitches at the beginning.
- > Sew a stitch and pull the fabric back at the desired stitch length.
- > Sew a stitch.
- > At the end sew 3 – 4 securing stitches.



7 Decorative stitches

7.1 Overview Decorative Stitches

Depending on the type of material, simple or more complex decorative stitches should be selected to best suit the material.

- Decorative stitches which are programmed with simple straight stitches are particularly appropriate for light-weight materials, e.g. the Decorative stitch No. 101.
- Decorative stitches which are programmed with triple straight stitches or with a few satin stitches are particularly appropriate for medium-weight materials, e.g. Decorative stitch No. 107.
- Decorative stitches which are programmed with satin stitches are particularly appropriate for heavy-weight materials, e.g. Decorative stitch No. 401.

For a perfect stitch formation, it is of advantage to use the same thread color for upper and bobbin thread and a stabilizer. With pile or longfiber materials, it is recommended to use an additional water-soluble stabilizer on the right side; a stabilizer which can be easily removed after sewing.

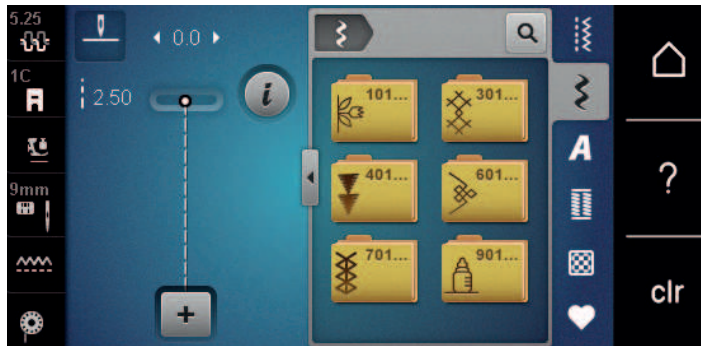

Decorative stitch	Category	Name
	Category 100	Natural stitches
	Category 300	Cross stitches
	Category 400	Satin stitches
	Category 600	Ornamental stitches
	Category 700	Heirloom stitches
	Category 900	Children stitches

7.2 Bobbin-Play

NOTICE

Inappropriate bobbin case is used

Damage of the bobbin case.

> Use the special bobbinwork case (optional accessory).

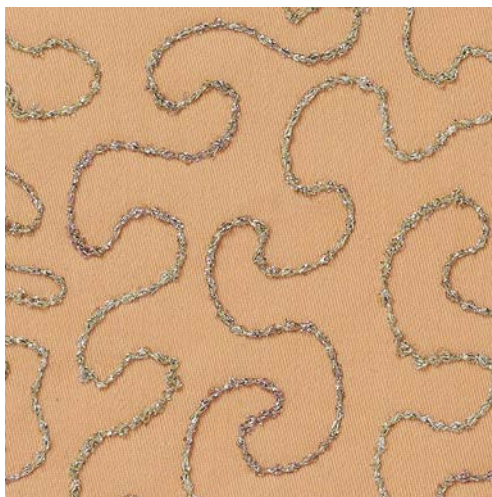

The bobbin can be filled with different thread material. For free-motion stitching to add texture. This method is similar to free-motion sewing, but it is done on the **wrong** side of the fabric.

The area to be sewn should be reinforced with embroidery stabilizer. The design can be drawn on the wrong side of the fabric. You can also draw the design on the front side of the fabric. The lines can be followed with a freely guided straight stitch, using polyester, cotton or rayon thread. The rows of stitching are visible on the wrong side of the fabric and serve as reference lines for the bobbin-thread sewing.

Bobbin-thread sewing can be done using the BSR function. It is recommended to guide your project at consistent speed evenly under the needle, following the lines of the design. The stabilizer must be removed after sewing.

First sew a sample to check what the result looks like on the wrong side of the fabric.

Not all decorative stitches are suitable for this technique. Using simple decorative stitches provide the best results. Avoid compact stitch types and beads of buttonholes.

- > Attach the Embroidery foot No. 20C.
- > Touch the icon «Decorative stitches».
- > Select the appropriate decorative stitch.
- > Turn the «upper Multifunctional knob» and the «Lower Multifunctional knob» to adjust the stitch length and the stitch width so that a nice stitch formation can be achieved even when using thick thread.
- > Touch the icon «Upper thread tension» and adjust the upper thread tension if necessary.



7.3 Sewing cross stitches

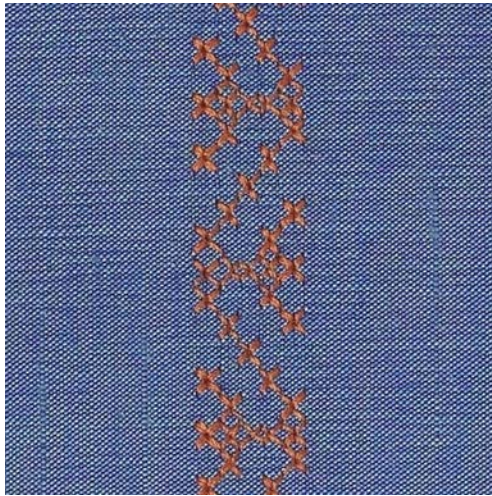

Cross stitch embroidery is a traditional technique and a charming addition to the other decorative stitches. If the cross stitches are sewn on a fabric with a linen texture, they look like hand-stitched cross stitching. When cross stitches are sewn with embroidery yarn, the stitch pattern appears fuller. Cross stitches are particularly used for home furnishing, trimmings on garments and embellishing in general. As every following line refers to the first row, it is important to stitch the first row in a straight line.

- > Fit the Reverse pattern foot No. 1C or Open embroidery foot No. 20C.
- > Select a cross stitch of the Category 300 and combine it as desired.
- > To ensure that the first row is sewn straight, we recommend using a seam guide (optional accessory) or the edge guide (optional accessory).
- > Stitch the second row next to the first at a distance of one presser foot's width or using the seam guide.

7.4 Pintucks





Pintucks

The technique reduces the size of the fabric piece. It is always advisable to plan in sufficient fabric. Pintucks are narrow stitched folds, which are normally sewn on the fabric before cutting out the pieces for the garment or the sewing project. They are suitable for embellishing or in combination with other heirloom embroidery techniques.

A more distinctive and relief-like effect can be achieved when the pintucks are corded, which means that they are sewn with an additional pintuck cord. Choose a pintuck cord that fits well into the grooves of the selected pintuck foot. The cord must be colorfast and shrink-proof.

Overview pintucks

Pintuck foot	Number	Description
	# 30 (optional accessory)	3 grooves For heavy-weight fabrics. In combination with the 4 mm double needle

Pintuck foot	Number	Description
	# 31 (optional accessory)	5 grooves For heavy to medium-weight fabrics. In combination with the 3 mm double needle
	# 32 (optional accessory)	7 grooves For light to medium-weight fabrics. In combination with the 2 mm double needle
	# 33 (optional accessory)	9 grooves For very light fabrics (without pintuck cord). In combination with the 1 or 1.6 mm double needle
	# 46C (optional accessory)	5 grooves In combination with the 1.6 – 2.5 mm double needle For very light to medium-weight fabrics.

Inserting the cord

- > Switch the machine off and disconnect it from the power supply system.
- > Remove the needle.
- > Remove the presser foot.
- > Remove the stitch plate.
- > Open the bobbin cover.
- > Pull the cord through the hook opening from the bottom and through the opening of the stitch plate.
- > Replace the stitch plate.
- > Close the bobbin cover.
- > Make sure that the cord slides through the little thread slot of the bobbin cover.

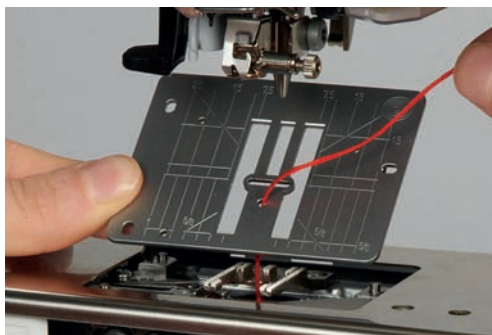

- > Touch the icon «Display alphabets» (1) to open an extended enter mode.



- > Select the letters.
- > Touch the icon (2) (standard setting) to use upper case letters.
- > Touch the icon (3) to use lower case letters.
- > Touch the icon (4) to use figures.
- > Touch the icon (5) to use special characters and mathematical symbols.



- > Touch the icon «DEL» to delete single letters of the entered text.
- > Touch the icon «Display alphabets» again to close the extended enter mode.

8.3 Altering font size

Block, Double block, Script and Comic alphabets as well as as Cyrillic can be downsized.



- > Touch the icon «Alphabets».
- > Select the font.
- > Select the letters.



- > Touch the icon «i»-Dialog.

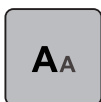









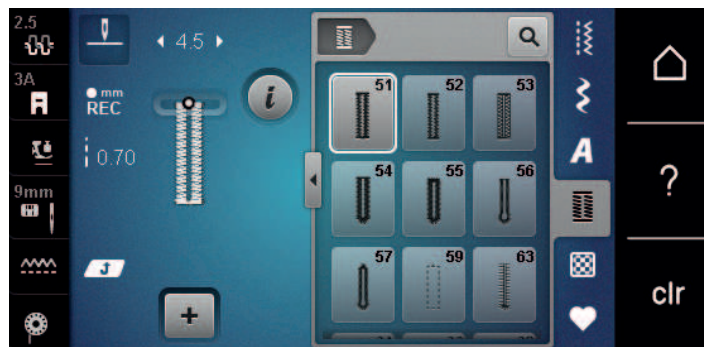

- > Touch the icon «Altering font size» to downsize the lettering.
- > Touch the icon «Altering font size» again to scale up the lettering to 9 mm.







9 Buttonholes

9.1 Overview Buttonholes

To create the correct buttonhole for every button, every purpose and for every garment, your BERNINA 540 is equipped with a considerable collection of buttonholes. The corresponding button can be sewn on automatically. Eyelets can also be sewn.



Buttonhole	Buttonhole number	Name	Description
	51	Standard buttonhole	For light to medium-weight fabrics; blouses, dresses, bedlinen.
	52	Standard buttonhole narrow	For light to medium-weight fabrics; blouses, dresses, children's and baby clothes, crafts.
	53	Stretch buttonhole	For any highly elastic jersey made from cotton, wool, silk and synthetic fibers.
	54	Round buttonhole with normal bartack	For light to medium-weight fabrics; dresses, jackets, coats, rainwear.
	55	Round Buttonhole with horizontal bartack	For medium-weight to heavy fabrics; dresses, jackets, coats, rainwear.
	56	Keyhole buttonhole	For heavy-weight, non-stretch fabrics; jackets, coats, leisure wear.
	57	Keyhole buttonhole with pointed bartack	For firm, non-stretch fabrics: jackets, coats, leisure wear.
	59	Straight stitch buttonhole	Program for staystitching buttonholes, for pocket openings, reinforcing buttonholes, especially for buttonholes in leather and imitation leather.
	63	Heirloom	For light to medium-weight woven fabrics; blouses, dresses, leisure wear, bedlinen.

Buttonhole	Buttonhole number	Name	Description
	64	Double-rounded buttonhole	For medium-weight to heavy fabrics made from different materials.
	66	Narrow buttonhole with double pointed bartack	Decorative buttonhole for medium-weight fabrics; blouses, dresses, jackets.
	69	Decorative buttonhole with double pointed bartack	For decorative buttonholes in firmer, non-elastic fabrics.
	60	Button sew-on program	For buttons with 2 and 4 holes.
	61	Eyelet with small zig zag	Openings for cords and narrow ribbons, for decorative work.
	62	Straight-stitch eyelet	Openings for cords and narrow ribbons, for decorative work.

9.2 Making use of the height compensation tool

When a buttonhole is to be sewn at right angles to the project edge, it is recommend to use the height compensation plates (optional accessory).

- > Place the plates from the back between the sewing project and the bottom of the slide to the thick part of the sewing project.

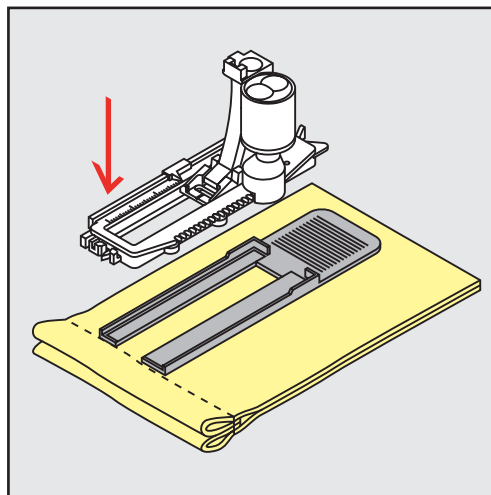

- > Lower the presser foot.

9.3 Using the compensation plate

When sewing a buttonhole in difficult materials, it is recommended to use the compensation plate for buttonholes (optional accessory). It can be used along with the Buttonhole foot No. 3A.

- > Insert the compensation plate carefully from the side.

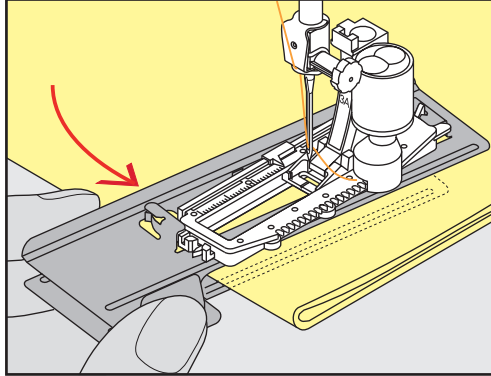

9.4 Marking buttonholes

- > For the buttonholes to be sewn manually, mark the position and the length on the fabric using chalk or a water-soluble pen.

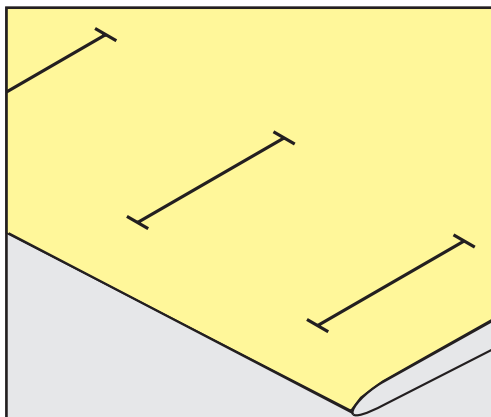

- > For the buttonholes to be sewn automatically, mark the complete length of 1 buttonhole on the fabric using chalk or a water-soluble pen. For any subsequent buttonholes mark the starting point.

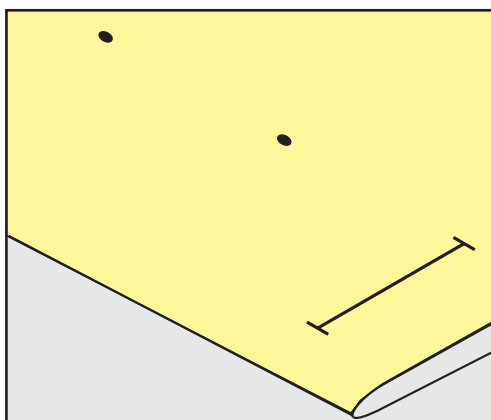

- > For keyhole and round buttonholes mark the length of the bead with chalk or a water-soluble pen on the fabric. For any subsequent buttonholes mark the starting point. The length of the keyhole is sewn additionally.

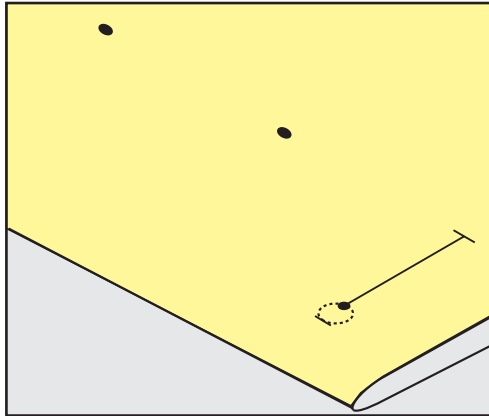

9.5 Cord

Using cord with the Buttonhole foot with slide No. 3A

Cords reinforce buttonholes and enhance their appearance and suit best for the Buttonhole No. 51. Ideal cords are Perle cotton No. 8, strong hand-sewing thread and fine crochet yarn. It is recommended to not hold the cord while sewing.

Prerequisite:

- The Buttonhole foot with slide No. 3A is attached and raised.
- > Insert the needle at the beginning of the buttonhole.
- > Guide the cord on the right side under the buttonhole foot.
- > Hook the cord over the pin at the back of the buttonhole foot.

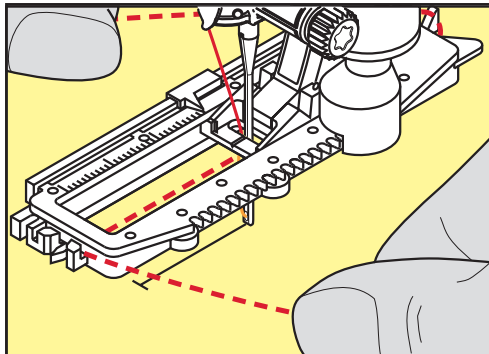

- > Pull the cord on the left side under the buttonhole foot to the front.

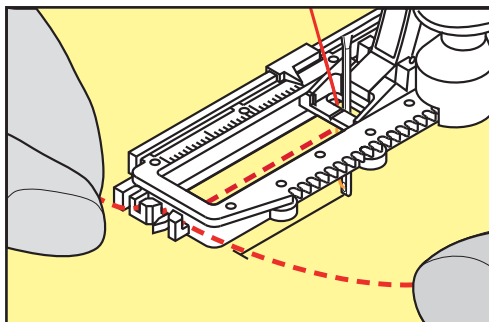

- > Pull the cord ends into the slits.
- > Lower the buttonhole foot.
- > Sew the buttonhole in the usual manner.
- > Pull the cord through the buttonhole until the loop disappears in the bartack.
- > Pull the ends of the cord through to the wrong side of the fabric (using a hand stitching-needle), knot or secure with stitches.

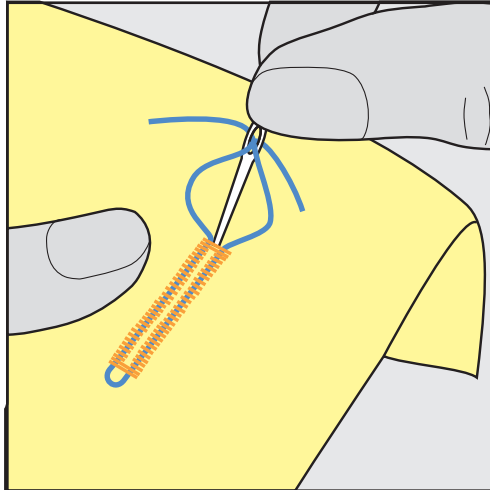

Using cord with the Buttonhole foot No. 3C (optional accessory)

Prerequisite:

- The Buttonhole foot No. 3 is attached and raised.
- > Insert the needle at the beginning of the buttonhole.
- > Hook the cord over the pin at the front of the buttonhole foot.

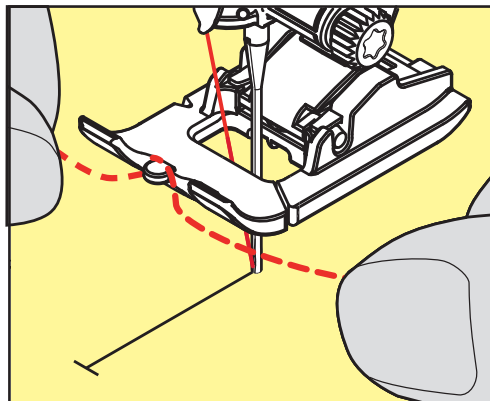

- > Pull both cords ends under the buttonhole foot to the back and place each a cord into a groove of the sole.

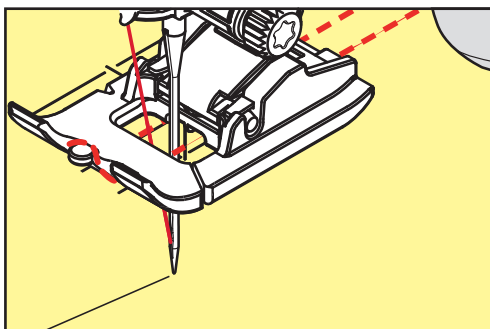

- > Lower the buttonhole foot.
- > Sew the buttonhole in the usual manner.
- > Pull the cord through the buttonhole until the loop disappears in the bartack.
- > Pull the ends of the cord through to the wrong side of the fabric using a hand stitching-needle and knot or secure with stitches.

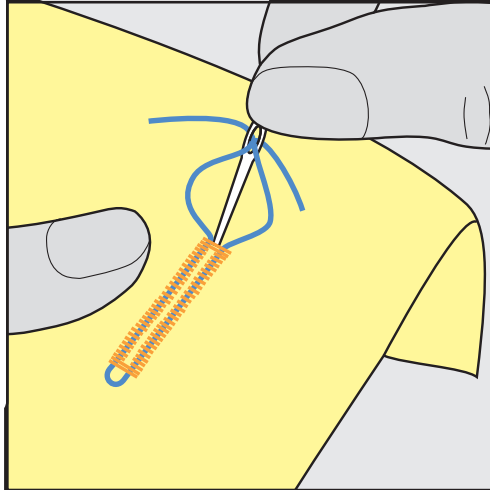

9.6 Sewing a test sample

Always sew a test sample of the buttonhole on the same fabric: It is recommended to use the same stabilizer and to select the same buttonhole. The test sample should also be sewn in the respective direction. By sewing a test sample the settings can be adjusted until the sewing result is satisfying.

When working with soft loosely woven materials or for buttonholes which are highly stressed, it is worth underlaying the buttonholes with the Straight stitch buttonhole No. 59. This is also recommended to reinforce buttonholes in leather, vinyl or felt.

Alterations of the balance when sewing a manual standard buttonhole as well as the keyhole and the round buttonhole affect both beads in the same way. With the manual keyhole or round buttonhole, the alterations affect both sides in the opposite way.

If the stitch counter function is used and alterations are made concerning the balance, the alterations affect both buttonhole beads differently.



- > Touch the icon «Buttonholes».
- > Select the buttonhole.
- > Select and attach the desired presser foot.
- > Place the fabric under the presser foot and lower the presser foot.
- > Press the foot control carefully and start sewing. Guide the fabric slightly.
- > Check the balance while sewing and adjust if necessary.
- > Check the test sample and make further amendments if necessary.

9.7 Determining the buttonhole slit width

The width of the buttonhole slit can be adjusted between 0.1 – 2.0 mm before sewing.



- > Touch the icon «Buttonholes».
- > Select the buttonhole.



- > Touch the icon «i»-Dialog.

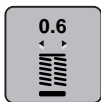

- > Touch the icon «Buttonhole slit width».
- > Turn the «Upper Multifunctional knob» or the «Lower Multifunctional knob» to adjust the buttonhole slit width as desired.

9.8 Determining the buttonhole length with the Buttonhole foot with slide No. 3A



The button can be centered in the yellow circle on the display. By turning the «Upper/Lower Multifunction knobs», the yellow circle can be enlarged or downsized to determine the diameter of the button.

Additionally to the diameter of the button, 2 mm are added automatically for the buttonhole length. If the diameter of the button is 14 mm, the buttonhole length is calculated 16 mm.

Prerequisite:

- The Buttonhole foot with slide No. 3A is attached.



- > Touch the icon «Buttonholes».
- > Select the buttonhole.



- > Touch the icon «i»-Dialog.



- > Touch the icon «Adjust the buttonhole length».
- > Turn the «Upper Multifunction knob» or the «Lower Multifunction knob» to adjust the buttonhole length.

9.9 Determining the buttonhole length with Buttonhole foot No. 3C (optional accessory)

With the Buttonhole foot No. 3C (optional accessory) the buttonhole length must be determined via the stitch counter function. The stitch counter function is suitable for all types of buttonholes. The left buttonhole bead is sewn forward, the right buttonhole bead is sewn in reverse. If alterations of the balance are made, the stitch counter function has to be saved for every buttonhole separately.

Prerequisite:

- The Buttonhole foot No. 3C (optional accessory) is attached.



- > Touch the icon «Buttonholes».
- > Select the buttonhole.



- > Touch the icon «i»-Dialog.



- > Touch the icon «Program the length with the stitch counter».
- > Sew the desired buttonhole length.
- > Stop the machine.

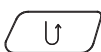

- > Push the button «Quick reverse» so that the machine sews the lower bartack and the second bead in reverse.
- > Stop the machine at the height of the first stitch.
- > Push the button «Quick Reverse» so that the machine sews the upper bartack and the securing stitches.
 - The length of the buttonhole remains saved and every subsequent buttonhole is sewn identically until the machine is switched off.

9.10 Sewing a buttonhole automatically

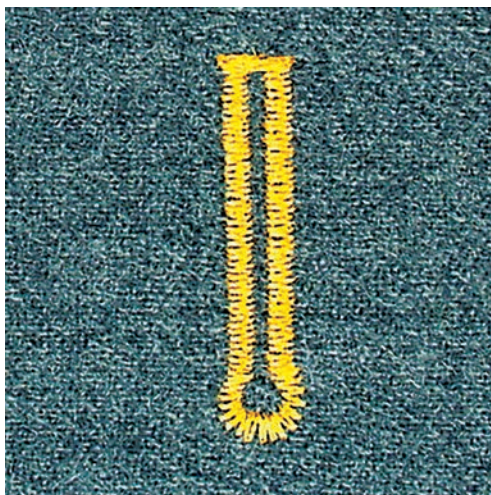
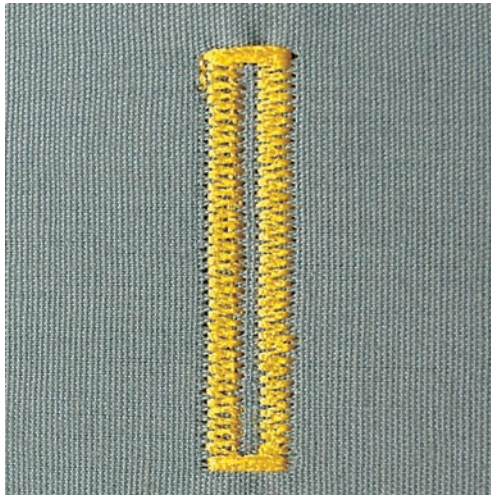

When the Buttonhole foot with slide No. 3A is used, the length of the buttonhole is measured automatically by the lens on the presser foot. The buttonhole will be duplicated and the machine switches to the next step automatically when the maximum length is reached. The Buttonhole foot with slide No. 3A is suitable for buttonholes of 4 – 31 mm in length, depending on the buttonhole type. The slide of the Buttonhole foot must lie perfectly flat on the fabric so that the length can be measured accurately. All the programmed buttonholes are the same length and of the same nice look.

Prerequisite:

- The Buttonhole foot with slide No. 3A is attached.



- > Touch the icon «Buttonholes».
- > Select the buttonhole No. 51 – 59, No. 63, 64, 66 or 69.
- > Sew the desired buttonhole length.

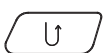

- > Push the button «Quick reverse» to program the length.



- > Push the button «Start/Stop» or the foot control.
 - The machine finishes the buttonhole automatically. All subsequent buttonholes are sewn at the same length.

9.11 Programming the Heirloom buttonhole

Prerequisite:

- The Buttonhole foot with slide No. 3A is attached.



- > Touch the icon «Buttonholes».
- > Select the Buttonhole No. 63.
- > Sew the desired buttonhole length.

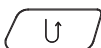

- > Push the button «Quick reverse» to program the length.
 - The machine finishes the buttonhole automatically. All subsequent buttonholes are sewn at the same length.

9.12 Sewing the manual 7-step buttonhole with the Buttonhole foot No. 3C (optional accessory)

The length of the buttonhole is determined manually when sewing. Bartack, eye and securing stitches are preprogrammed. The individual steps can also be selected by scrolling using the arrow icons or by touching the button «Quick Reverse».

Prerequisite:

- The Buttonhole foot No. 3C (optional accessory) is attached.



- > Touch the icon «Buttonholes».
- > Select the Buttonhole No. 51.



- > Touch the icon «i»-Dialog.



- > Touch the icon «Adjust the length manually».
 - Step 1 the display is activated for the buttonhole start.
- > Sew the desired buttonhole length.
 - Step 2 is activated.



- > Stop the machine at the desired length of the bead or at the end of the length marking.
- > Touch the icon «Scroll down» so that step 3 appears.
 - The machine sews straight stitches in reverse.
- > Stop at the height of the first stitch at the start of the buttonhole.
- > Touch the icon «Scroll down» so that step 4 appears.
 - The machine sews the upper bartack and stops automatically.
- > Touch the icon «Scroll down» so that step 5 appears.
 - The machine sews the second bead.
- > Stop the machine at the height of the first bead.

- > Touch the icon «Scroll down» so that step 6 appears.
 - The machine sews the bottom bartack and stops automatically.
- > Touch the icon «Scroll down» so that step 7 appears.
 - The machine secures and stops automatically.

9.13 Sewing the manual 5-step buttonhole with the Buttonhole foot No. 3C (optional accessory)

The length of the buttonhole is determined manually when sewing. Bartack, eye and securing stitches are preprogrammed. The individual steps can also be selected by scrolling using the arrow icons or by touching the button «Quick Reverse».

Prerequisite:

- The Buttonhole foot No. 3C (optional accessory) is attached.



- > Touch the icon «Buttonholes».
- > Select the Buttonhole No. 54.



- > Touch the icon «i»-Dialog.



- > Touch the icon «Adjust the length manually».
 - Step 1 the display is activated for the buttonhole start.
- > Sew the desired buttonhole length.
 - Step 2 is activated.



- > Stop sewing at the desired length of the bead or at the marking.
- > Touch the icon «Scroll down» so that step 3 appears.
- > The machine sews the eye or the keyhole and stops automatically.
- > Touch the icon «Scroll down» so that step 4 appears.
 - The machine sews the second bead in reverse.
- > Stop the machine at the first stitch where the buttonhole starts.
- > Touch the icon «Scroll down» so that step 5 appears.
 - The machine sews the upper bartack and secures automatically.

9.14 Cutting the buttonhole open with the seam ripper

- > Place a pin in each end of the buttonhole to avoid accidental cutting into ends of buttonhole.

- > Cut the buttonhole from both ends to the middle.

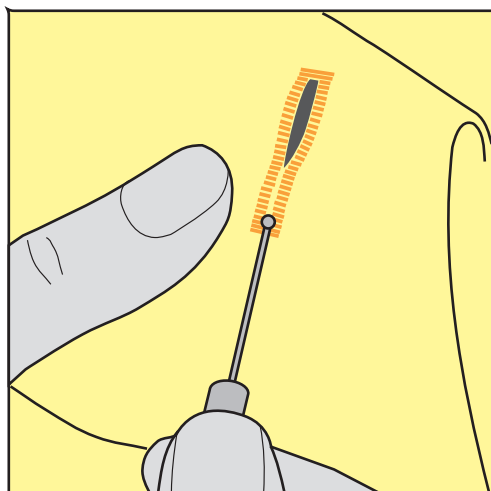

9.15 Cutting open buttonholes with the buttonhole cutter (optional accessory)

- > Place the fabric on an appropriate piece of wood.

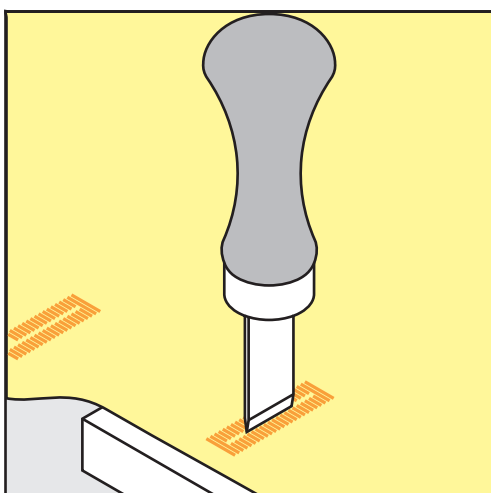

- > Position the cutter in the center of the buttonhole.
- > Press down on the cutter with your hand.

9.16 Sewing on buttons

The button sew-on program can be used to sew on buttons with two or four holes, press studs or snap fasteners.

Recommended sewing program:

Button sewing-on program No. 60

Recommended presser foot :

Button-sew-on foot No. 18 (optional accessory)

Alternative presser feet:

- Reverse pattern foot No. 1 or 1C
- Darning foot No. 9 (optional accessory)
- Reverse pattern foot No. 34 or 34C (optional accessory)

Adjusting the thread shank

For buttons on thicker fabrics, increase the thread shank = the distance between the button and the fabric.

Buttons sewn on thin fabrics or buttons for decorative purposes only are stitched without a «thread shank».

NOTICE! The adjustment of the thread shank is only possible when using the Button sew-on foot No. 18.

- > Loosen the screw on the back of the presser foot.
- > Push the bar upwards according to the thickness of the fabric.
- > Tighten the screw.

Sewing on buttons

Prerequisite:

- The shank length is adjusted according the fabric thickness.
- The Button sew-on foot No. 18 or an alternative presser foot is attached.
- The attached presser foot has been selected in the user interface.
- The feed dog is lowered.



- > Touch the icon «Buttonholes».
- > Select the Button sew-on Program No. 60.
- > Turn the handwheel until the bobbin thread comes up.
- > **NOTICE! The Button sew-on program always starts above the left hole of the button.**
Position the button on the fabric. Place the button and the fabric beneath the needle so that the needle stitches into the left hole.
For buttons with 4 holes, sew the first front pair of holes first.
- > Lower the presser foot.
- > Perform the first stitches in the left hole via the handwheel.
- > Keep turning the handwheel until the needle changes to the right hole. In doing so, check whether the needle goes into the right hole. If necessary, adjust the stitch width by turning the upper Multifunction knob.
- > Hold the threads and push the foot control.
 - The machine sews on the button and stops automatically.
- > For increased stability, sew the Button sew-on program again.
- > Cut the threads with the machine. Alternatively, pull the sewing projects from under the sewing machine and trim the threads by hand. Pull the upper thread to the wrong side of the fabric and knot it with the bobbin thread.

9.17 Sewing eyelets



For increased stability sew the eyelet twice.

Prerequisite:

- The Reverse pattern foot No. 1C or the Open embroidery foot No. 20C is attached.



- > Touch the icon «Buttonholes».
- > Select the Eyelet Program No. 61 or No. 62.
- > Turn the «Upper Multifunctional knob» or the «Lower Multifunctional knob» to alter the size of the eyelet.
- > Sew the Eyelet Program.
 - The machine stops automatically at the end of the Eyelet Program.
- > Use an awl, punch pliers or a hole punch to open the eyelet.

10 Quilting

10.1 Overview Quilt Stitches

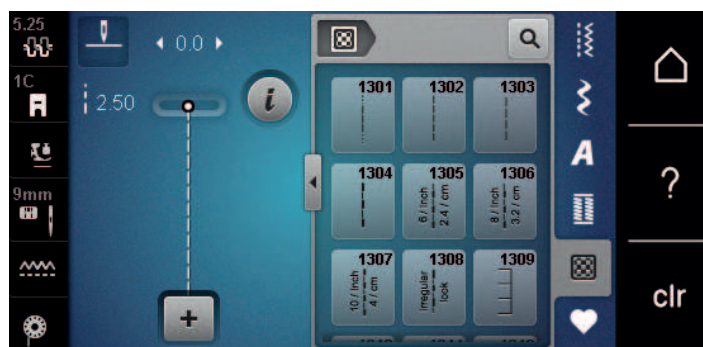

Stitch pattern	Stitch number	Name	Description
	1301	Quilting, securing program	To secure at the sewing start and sewing end with short stitches forward.
	1302	Quilting straight stitch	Straight stitch at 3 mm stitch length.
	1303	Piecing stitch/Straight stitch	Straight stitch at 2 mm stitch length.
	1304 – 1308	Handlook quilt stitch	Imitation of handlook quilt stitch with monofilament.
	1309 – 1314	Blanket stitch	For appliqué and sewing on ribbons.
	1317 – 1327 1329 – 1342 1344, 1345	Decorative quilting stitches	For "Crazy Patchwork" and embellishing.
	1315	Satin stitch	For appliqué.
	1316	Blindstitch narrow	To sew blind stitches.
	1331	Stippling stitch	Imitation of stipple quilting.
	1332	Feather stitch	For "Crazy Patchwork" and embellishing.
	1333 – 1338	Feather stitch variations	For "Crazy Patchwork" and embellishing.

10.2 Quilting, Securing Program

Prerequisite:

- The Reverse pattern foot No. 1C is attached.



- > Touch the icon «Quilt stitches».
- > Select Quilt stitch pattern No. 1301.
- > Press the foot control.
 - The machine sews 6 stitches forward automatically when sewing is started.
- > Sew the seam in the desired length.

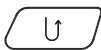

- > Push the button «Quick reverse».
 - The machine sews 6 stitches forward automatically and stops automatically at the end of the Securing Program.

10.3 Sewing handlook quilt stitches

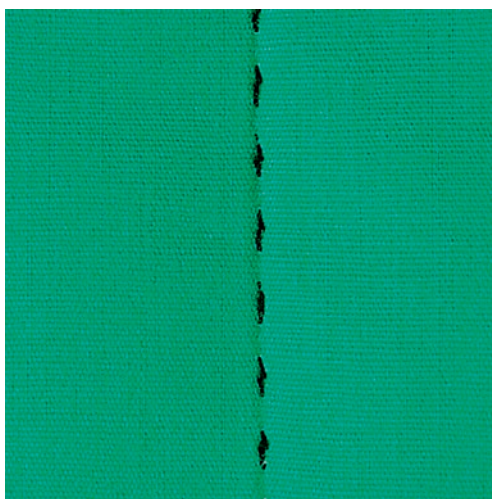

Handlook quilt stitches are suitable for all fabrics and sewing projects which should look hand-sewn. It is recommended to use a monofilament thread as upper thread and an embroidery thread as bobbin thread. The sewing speed should be moderate to prevent the monofilament from breaking. If required, the upper thread tension and the balance can be adjusted to the sewing project and the desired quilt stitch.

Prerequisite:

- The Reverse pattern foot No. 1C is attached.



- > Touch the icon «Quilt stitches».
- > Select Handlook quilt stitches No. 1304 – 1308.
- > If required, adjust the upper thread tension and the balance to the sewing project and the desired quilt stitch.
- > Press the foot control or the button «Start/Stop» to start the machine.

10.4 Guiding the quilt work freely



Quilt gloves with rubber fingertips (optional accessory) will help when guiding the fabric.

It is recommended to use the slide-on table and the Free Hand System. With free-motion quilting, it is of advantage to quilt from the center outwards and to guide the fabric using smooth, round movements to form the design of your choice. Free-motion quilting and darning are based on the same free-motion principles.

With stipple quilting, entire surfaces of the fabric are filled with quilt stitches. The single lines of stitching are rounded and never cross one another.

Prerequisite:

- The top layer, the batting and the backing are pinned together or basted.
- The feed dog is lowered.
- The Darning foot No. 9 (optional accessory) is attached.



- > Touch the icon «Practical stitches».
- > Select the Straight stitch No. 1.
- > Adjust the upper thread tension and the balance to the sewing project if necessary.
- > Press the foot control or the button «Start/Stop» to start the machine.
- > Hold both hands close to the presser foot like an embroidery hoop to guide the fabric.
- > If the thread is lying on top of the fabric, slow down the movement.
- > If there are knots on the wrong side of the fabric, move the fabric more quickly.

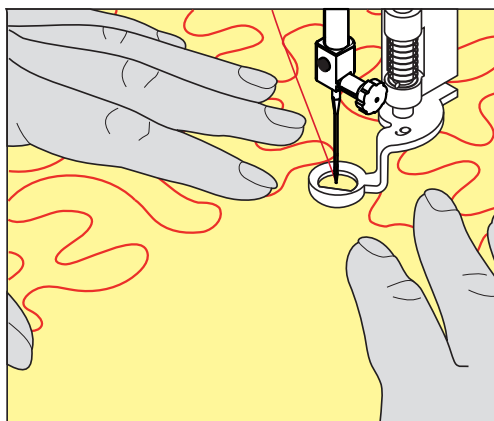

11 BERNINA Stitch Regulator (BSR)

The BERNINA Stitch regulator equalizes the stitch length which results of the free movement of the fabric while free-motion sewing - a sewing technique which grows more and more popular. When free-motion sewing with the BSR presser foot, every stitch is equally long and the stitch formation is perfectly regular.

As soon as the BSR presser foot is attached and the feed dog is lowered, the selection menu of the desired mode appears in the display of the machine. The BSR presser foot can be used with sewing straight stitch as well as zig zag.

The BSR presser foot reacts on the movement of the fabric and therefore controls the speed of the machine up to the highest possible speed. It can be said: The faster the movement of the material, the higher the speed of the machine.

If the fabric is moved too quickly, an acoustic signal sounds. The beeper can be activated or deactivated in the «BSR» display. The sound of the beeper can also be activated or deactivated in the Setup Program.

11.1 BSR mode 1

The BSR function can be controlled via the foot control or with the button «Start/Stop». Start the BSR mode. At the BSR presser foot a red light is on. By moving the fabric the machine accelerates. If the fabric isn't moved, securing in place is possible without pressing an additional button. When working via the foot control or when using the button «Start/Stop», the BSR mode doesn't stop automatically.

11.2 BSR mode 2

The BSR function can be controlled via the foot control or the button «Start/Stop». The machine starts only when the foot control or the button «Start/Stop» is pressed and the fabric is moved simultaneously. Without moving the fabric, the BSR2 modus stops after about 7 seconds. The red light goes off (only when working with the button «Start/Stop»). When working via the foot control, the red light doesn't go off.

11.3 BSR function with Straight stitch No. 1

This function allows free-motion quilting with straight stitch and a pre-programmed stitch length up to 4 mm. The programmed stitch length is maintained within a certain speed, independent of the fabric movement.

11.4 BSR function with Zig zag No. 2

The zig zag can be used e.g. for thread painting. The set stitch length will **not** be maintained when sewing the zig zag stitch, but the BSR function simplifies the application.

11.5 Sewing preparations for quilting

Attach the BSR presser foot

Prerequisite:

- The machine is switched off.
 - The needle is raised.
 - The presser foot is raised.
- > Remove the fitted presser foot.
- > Attach the BSR presser foot.

- > Insert the plug for the cable vertically into the BSR connection (1) until you feel it click into place.



- > Switch the machine on.
 - The BSR display opens and the BSR 1 mode is activated.

Changing the presser foot sole

NOTICE

The lens of the BSR presser foot is dirty

The machine doesn't recognize the BSR presser foot.

- > Clean the lens with a soft, slightly damp cloth.

The standard stitch length is 2 mm. When sewing small shapes and stippling it is recommended to shorten the stitch length to 1 – 1.5 mm.

- > Raise the needle.
- > Raise the BSR foot.
- > Switch the machine off and disconnect it from the power supply system.
- > Remove the BSR foot from the machine.
- > Press both push buttons at the BSR foot against each other.

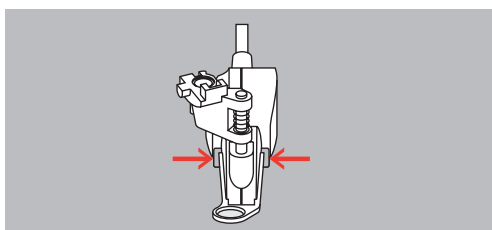

- > Pull the presser foot sole out of the guide downwards.
- > Insert the new presser foot sole into the guide and push upwards until it clicks into place.
- > Attach the BSR presser foot.

11.6 Using the BSR mode

The BSR function can be controlled via the foot control or the button «Start/Stop».



Starting via the foot control: The foot control needs to be pressed while quilting. The machine keeps running in the BSR1 mode until the foot control is released, even if the fabric isn't moved.

If quilting is stopped in the BSR2 mode, the machine sews another stitch depending on the needle position and stops with needle position up.

Prerequisite:

- The slide-on table is attached.



- The knee lifter of the Free Hand System is attached.
- > Lower the feed dog.
- > Select the desired BSR mode.
- > Lower the presser foot.
-  > Push the button «Start/Stop» or press the foot control and keep it pressed to start the BSR mode.
 - At the BSR foot a red light is on.
- > Move the fabric to control the speed of the machine in the BSR mode.
-  > Push the button «Start/Stop» again or release the foot control to stop the BSR mode.
 - The BSR mode stops and the red light at the presser foot goes off.
- > Touch the icon BSR (1) to deactivate the BSR mode and to quilt without automatic stitch length.

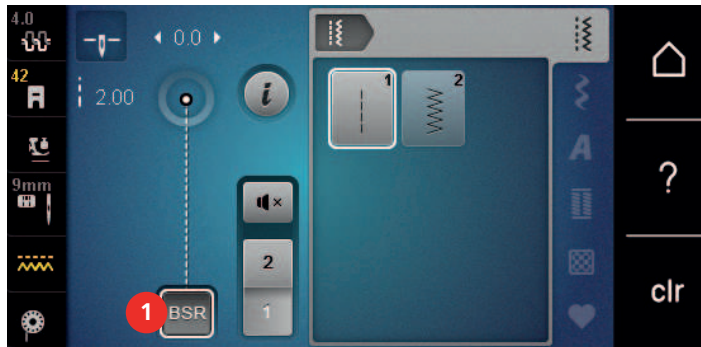

11.7 Securing

Securing in BSR1 mode with the button «Start/Stop»

Prerequisite:

- The BSR presser foot is attached and connected with the machine.
- The BSR display is opened and the BSR1 mode is activated.

- > Lower the feed dog.
- > Lower the presser foot.
-  > Push the button «Needle up/down» twice.
 - The bobbin thread is brought up.

- > Hold the upper and the bobbin thread.

-  > Push the button «Start/Stop».
 - Start the BSR mode.

- > Sew 5 – 6 securing stitches.
-  > Push the button «Start/Stop».
 - The BSR mode stops.
- > Cut the thread.

Securing in BSR2 mode

Prerequisite:

- The BSR presser foot is attached and connected with the machine.
- The BSR display is open and the BSR2 mode is activated.

- > Lower the presser foot.
-  > Touch the icon «i»-Dialog.





> Touch the icon «Securing».



> Press the foot control or the button «Start/Stop».

By moving the fabric some short securing stitches are sewn, then the programmed stitch length is activated and the securing function is deactivated automatically.



12 My BERNINA Embroidery

12.1 Overview Embroidery module







- | | | | |
|---|--------------------------------|---|-----------------------------|
| 1 | Release lever/carrying handle | 4 | Guide rails for the machine |
| 2 | Embroidery arm | 5 | Connection to the machine |
| 3 | Coupling for securing the hoop | | |

12.2 Supplied accessories Embroidery module

Overview accessory Embroidery module

Illustration	Name	Purpose
	Embroidery foot #26	For embroidering, darning and free-motion quilting.
	Large oval embroidery hoop	To embroider large embroidery motifs or motif combinations up to 145 x 255 mm (5.70 x 10.04 in). Including the template for precise fabric positioning.

Illustration	Name	Purpose
	Medium embroidery hoop	To embroider medium-sized embroidery motifs up to 100 x 130 mm (3.94 x 5.12 in). Including the template for precise fabric positioning.
	USB Connecting cable	To transfer data from the computer to the machine or vice versa.
	Embroidery needle assortment	For embroidering.
	Template holder	To place and remove the template in or out of the embroidery hoop.
	Net for upper thread spool	To support an even unwinding of the thread with slippery embroidery threads.

12.3 Overview User Interface

Overview functions/visual information

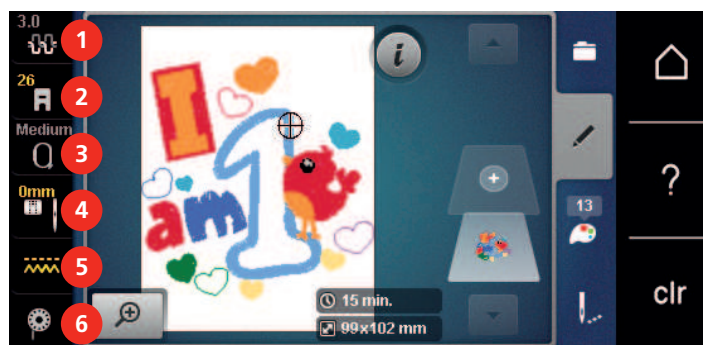

- | | | | |
|---|---|---|---|
| 1 | Upper thread tension | 4 | Stitch plate/Needle selection |
| 2 | Presser foot display/Presser foot selection | 5 | Feed dog up/down |
| 3 | Embroidery hoop selection/Embroidery hoop display | 6 | Instruction how to thread the bobbin thread display |

Overview System settings

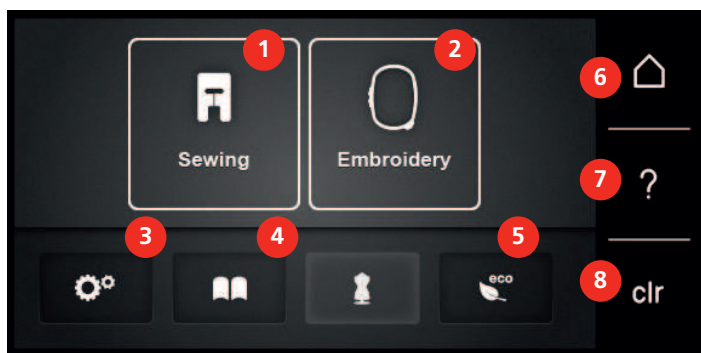

- | | | | |
|---|-----------------|---|-------------------------|
| 1 | Sewing mode | 5 | eco-Modus |
| 2 | Embroidery mode | 6 | Home |
| 3 | Setup Program | 7 | Help |
| 4 | Tutorial | 8 | Back to default setting |

Overview Selection menu embroidery

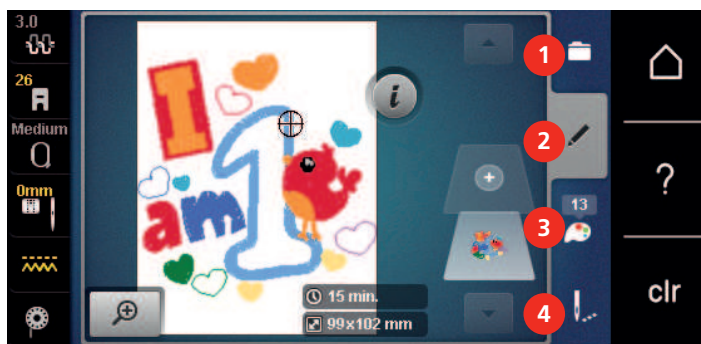

- | | | | |
|---|-----------------------------|---|-------------------|
| 1 | Selection embroidery motifs | 3 | Color information |
| 2 | Editing embroidery motifs | 4 | Embroidery |

12.4 Important Embroidery information

Upper thread

A good quality thread (brand manufacturer) is essential for embroidery so that the embroidery is not affected negatively because of poor thread or thread breakage.

Embroidery is particularly effective if you use 40wt glossy rayon or polyester embroidery threads as upper threads. They are available in a wide range of colors for beautiful embroidery.

- Glossy polyester with a brilliant sheen is a hard wearing, colorfast thread and has a high tensile strength which is suitable for all types of embroidery.
- Rayon is a soft viscose fiber with a brilliant sheen and suitable for fine, delicate embroidery, or items that will not receive excessive wear and tear.
- Metallic thread is a light to medium-weight thread suitable for special effects in embroidery.
- When working with metallic threads, the automatic bobbin thread cutter should be deactivated. The other thread cutters shouldn't be used either because the knives are likely to wear off very quickly.

- When using metallic threads, the speed and the upper thread tension should be reduced.



Bobbin thread

In most cases black or white bobbin thread is used for embroidering. When both sides should have the same look, it is recommended to use the same color for bobbin and upper thread.

- Bobbin Fill is an especially soft and light polyester thread which is suited well to be used as bobbin thread. This special bobbin thread ensures a steady thread tension and an optimal intertwining of the upper and bobbin thread.
- Darning and embroidery threads are fine mercerized cotton threads which are suitable for embroidery on cotton.



Selecting the embroidery file format

In order that embroidery motifs can be read by the BERNINA embroidery machine, they have to be created by the BERNINA Embroidery software and exported as .EXP file. Besides the actual embroidery file, a .BMP file and an .INF file are generated additionally. The .BMP file allows a preview of the embroidery motif and the .INF file provides the information on the thread colors. **Please note:** If the .INF file is missing, the embroidery motif cannot be displayed in the real color but only in standard colors. In this case, the colors can be entered manually in the color overview of the motif on the machine.

Additionally, following embroidery formats can be read by the machine: .PES, .PEC, .XXX, .PCS, .JEF and .DST. BERNINA International AG doesn't warrant that embroidery motifs which have not been created or converted by the BERNINA Embroidery software can be correctly read and embroidered.

Simple motifs with a low stitch count are suitable for embroidery on fine material. Densely embroidered motifs, e. g. embroidered motifs with multiple color and embroidery direction changes, are suitable for medium and heavy-weight material.



Embroidery test

For the embroidery test, always use the original material reinforced with the same stabilizer as will be used later. For the embroidery test it is recommended to use the same colors, threads and needles which are planned to be used for the embroidery project.

The size of the embroidery motif

Embroidery motifs can be enlarged or downsized on the embroidery machine or on the PC using the BERNINA Embroidery software (optional accessory). Enlargements or reductions up to 20% achieve the best results.

Embroidering motifs by third-party providers

BERNINA recommends uploading embroidery motifs of any file format via the free program «ART-Link» to the machine or a USB stick. Using «ART-Link» ensures that the embroidery motif can be read and embroidered correctly. «ART-Link» can be downloaded for free at www.bernina.com.

Underlay stitches

Underlay stitches are the foundation of a motif and are used to stabilize the base material and hold it in shape. They also prevent the covering stitches of the motif from sinking into the knit or the nap of the material.

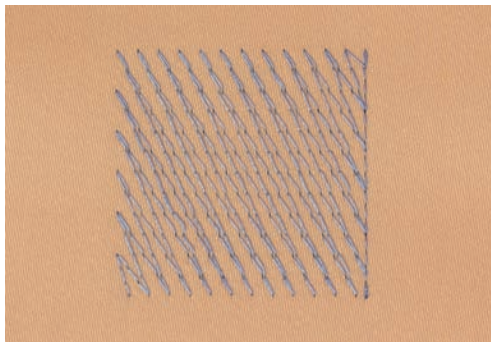

Satin or Leaf stitch

The needle moves left to right and vice versa. The result is a very dense, covering zig zag stitching to fill the shape. Satin stitching fills are ideal for narrow and small shapes. Satin stitching is, however, not suitable for larger areas, since wide stitches are too loose and do not cover the fabric properly. In addition there is the risk that with too long stitches the threads could catch on something which would damage the embroidery.

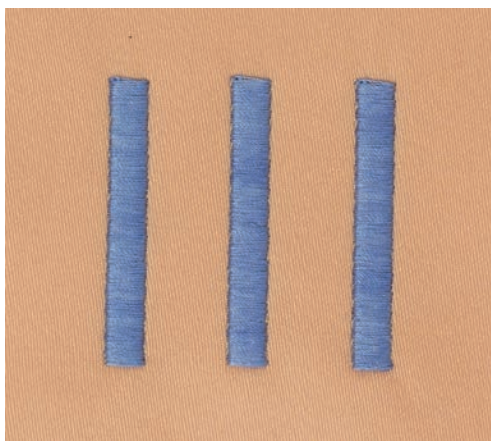

13 Embroidering preparation

13.1 Attaching the Module

Prerequisite:

- Extension table must not be fitted.
- > Make sure that the module and the machine are placed on a stable, even surface.
- > Ensure that the embroidery arm can move freely.
- > Carefully slide the embroidery module from left to right into the machine's embroidery module connection (1) and the guide rail (2).

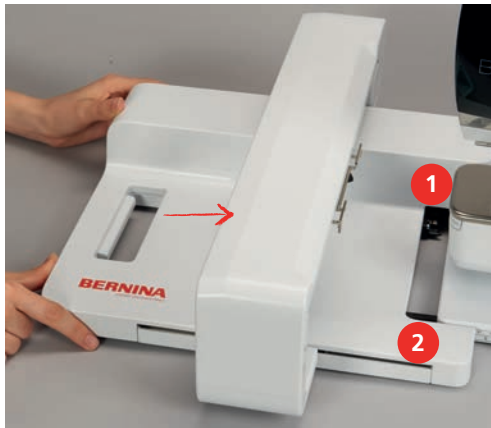

13.2 Removing the embroidery module

- > Push the release lever (1) at the carrying handle of the embroidery module, keep it pressed and at the same time, move the embroidery module carefully to the left.



13.3 Preparing the machine

lower the feed-dog

- > Touch the «Feed dog up/down» button to lower the feed dog.



- > Fit the straight and CutWork stitch plate (optional accessory).
- > Fit the needle.
- > Fit the embroidery foot.

Selecting an embroidery motif

All of the embroidery motifs can be either directly embroidered or can be changed using different functions offered by the embroidering machine. Please find all the embroidery motifs at the end of this instruction manual. In addition to that, embroidery motifs can be loaded from the personal memory or from the BERNINA USB stick (optional accessory).



- > Touch the icon «Home».



- > Touch the icon «Embroidery mode».
- > Select the folder for alphabet, embroidery motifs or your own embroidery motifs.

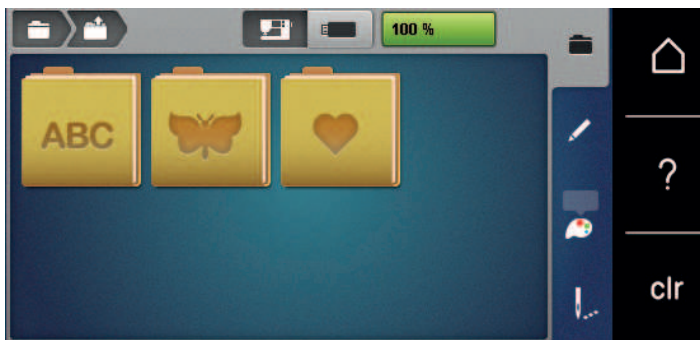

- > To open an embroidery motif category, select a folder.
- > To select an embroidery motif, either scroll through the view and select the required embroidery motif, or touch the icon «Select by number», enter the number for the embroidery motif and select the embroidery motif with the white frame.



13.4 Embroidery foot

Attaching the embroidery foot

- > Raise the needle.
- > Raise the presser foot.
- > Switch the machine off and disconnect it from the power supply system.
- > Push the clamping lever up (1).

- > Remove the presser foot (2).



- > Insert the embroidery foot from below into the bracket.
- > Press the clamping lever down.

Selecting the presser foot in the User Interface

After having attached the respective embroidery foot (Embroidery foot No. 26, supplied accessory with the embroidery module), you can select and save it on the machine. Moreover, alternative feet are displayed which will also be suitable for the selected embroidery motif.

- > Switch the machine on.
- > Select the embroidery motif.
- > Touch the icon «Presser foot display/Presser foot selection».
- > Select the attached embroidery foot.



13.5 Needle and stitch plate

Inserting the embroidery needle



Embroidery needles of the type 130/705 H-SUK provide a larger eye and are slightly rounded. This avoids thread abrasion when using Rayon- and cotton embroidery thread. Depending on the embroidery thread use a size No. 70-SUK to No. 90-SUK needle.

- > Raise the needle.
- > Switch off the machine and disconnect it from the power supply.
- > Remove the fitted foot.

- > Loosen the fixing screw for the needle by hand.

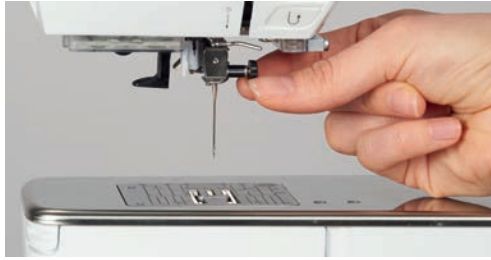

- > Pull the needle downwards.
- > Hold the new needle with the flat side to the rear.
- > Slide the needle upwards as far as it will go.
- > Tighten the fixing screw by hand.

Selecting the embroidery needle in the User Interface

After having changed the needle, it can be checked whether or not it is suitable to be used together with the selected stitch plate.



- > Touch the icon «Needle/Stitch plate selection».
- > Select the attached needle.



- If the selected needle is suitable in combination with the stitch plate, sewing can be started.
- If the selected needle is not suitable in combination with the stitch plate, starting the machine is automatically prevented.

Selecting the needle type and the needle size

Convenient memory function: To prevent a loss of information, the needle type and the needle size can be saved additionally on the machine. The saved needle type and the saved needle size can be checked at any time.



- > Touch the icon «Stitch plate/Needle selection».



- > Touch the icon «Needle type/Needle size».
- > Select the needle type (1) of the inserted needle.

- > Select the needle size (2) of the inserted needle.

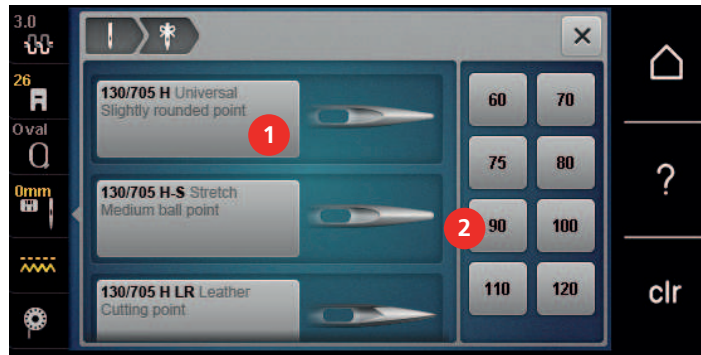

Adjusting the needle position up/down



- > To pull the thread upwards, touch the icon «Needle up/down».
 - The needle is lowered and raised once.

Attaching the stitch plate

There is a small hole in the area of the needle on the CutWork/straight stitch plate (optional accessory). The thread draw-in (thread knotting of upper thread and bobbin thread) is therefore optimized. This results in a nicer stitch formation.

- > Touch the icon «Feed dog up/down» to lower the feed dog.



- > Switch off the machine and disconnect it from the power supply.
- > Remove the needle.
- > Remove the presser foot.
- > At the marking on the rear of the stitch plate, push the stitch plate downwards until it tips.



- > Remove the stitch plate.
- > Position the openings on the CutWork/straight stitch plate (optional accessory) above the corresponding guide pins and push them downwards until they click into place.

Selecting the stitch plate in the User Interface

After having replaced the stitch plate, it can be checked whether it can be used together with the selected needle.



- > Touch the icon «Stitch plates/Needle selection».
- > Select the stitch plate CutWork/Straight (optional accessory).



Thread-up command

The machine must be ready for embroidery to bring up the bobbin thread. The bobbin thread can be brought up in one step for a manual knotting. If no securing stitches are wanted, it is recommended to deactivate the securing stitches in the Setup.



- > Hold the upper thread.
- > Press the button «Needle up/down».
 - The bobbin thread is brought up automatically.

13.6 Embroidery hoop

Overview Embroidery hoop selection

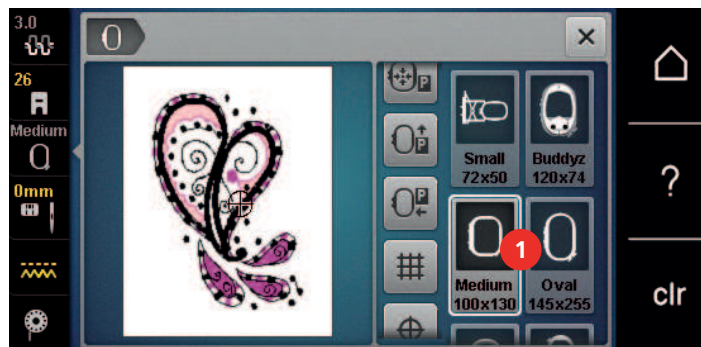

1 Hoop selection

Selecting the embroidery hoop

The best embroidery result is achieved when the smallest possible embroidery hoop for the embroidery motif is selected.

The embroidery motif has a pre-set size which is displayed.

Prerequisite:

- The embroidery motif is selected.

Using water-soluble stabilizer



For lace embroidery it is recommended to hoop 1 – 3 layers of water-soluble stabilizer in the embroidery hoop. As the embroidery motif is not embroidered on the fabric, only the thread embroidered motif is left. The embroidery motifs should be combined with short stitches otherwise the individual motifs may fall out.

Water-soluble stabilizers are ideal for fine, sheer fabrics where other stabilizers may show through the embroidery stitches as well as for lace embroidery. The stabilizer dissolves in water. Water-soluble stabilizers are an ideal protection for looped pile fabrics preventing the loops from being damaged. It prevents threads from sinking into the material and keeps the fabric pile from poking through the embroidery.

- > Place the stabilizer on the underside of the material.
- > Use adhesive spray to adhere stabilizer if necessary.
- > For material with a pile, reinforce with additional, suitable stabilizer on the wrong side.
- > Place all the layers together into the embroidery hoop.
- > After dissolving, lay the motif down flat and let dry.

Preparing the embroidery hoop

The embroidery hoop consists of an outer and an inner hoop. There is a corresponding template for every hoop. The area to be embroidered is marked in 1 cm (0.39 inch) squares. The center and corner points are marked with holes. The required marks can be transferred to the material.

- > Mark the center of an embroidery motif on the fabric, using a water-soluble pen.

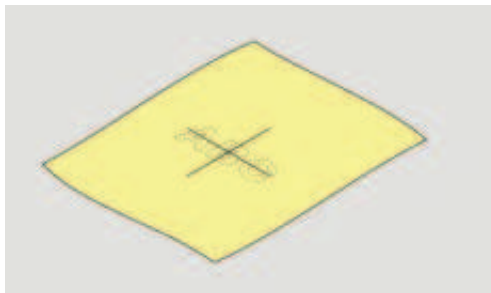

- > Loosen the screw on the outer hoop.
- > Remove the inner hoop.
- > Make sure that the arrows marks of both hoops match.
- > Attach the template holder.
- > Place the template in the inner hoop, so the BERNINA logo is at the front edge at the arrow mark until it clicks into place.

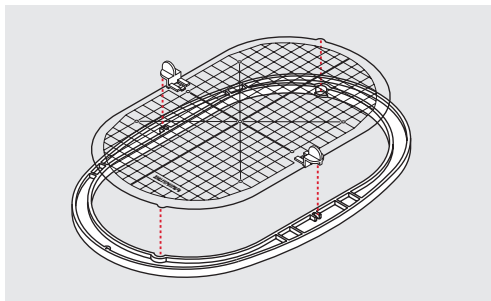

- > Place the material under the inner hoop.
- > Line up the marked center point on the center of the template.

Overview Embroidery functions

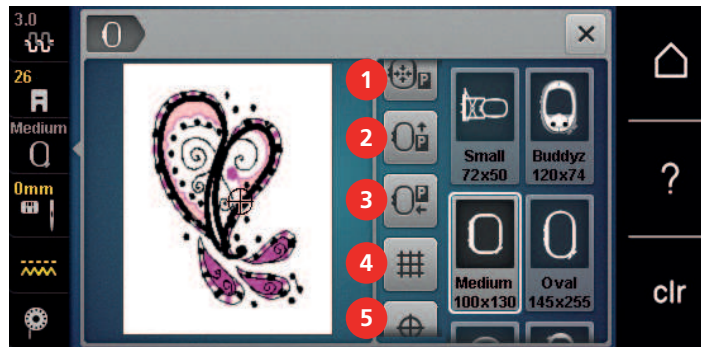

- | | | | |
|---|---|---|--|
| 1 | Centering the embroidery hoop to the needle | 4 | Grid on/off |
| 2 | Moving the hoop to the back | 5 | Motif center |
| 3 | Moving the module for the sewing mode | 6 | Virtual Positioning (is visible while scrolling) |

Center the needle to the embroidery hoop

Relocating the embroidery hoop facilitates threading when the needle is close to the embroidery hoop.



- > Touch the icon «Embroidery hoop display/Embroidery hoop selection».



- > Touch the icon «Center the needle to the embroidery hoop».
- > Threading the upper thread.



- > Push the button «Start/Stop» to move the embroidery hoop back to the last position.

Moving the hoop to the back

To facilitate changing the bobbin, it is recommended to move the hoop to the back before threading. This makes it easier to open the bobbin cover.



- > Touch the icon «Embroidery hoop display/Embroidery hoop selection».



- > Touch the icon «Move the hoop to the back».
- > Thread the bobbin thread (see page 44).



- > Push the button «Start/Stop» to move the embroidery hoop back to the last position. If necessary, pull the upper thread back.

Moving the module for the sewing mode

The embroidery module can be positioned so that any sewing projects can be carried out even if the module is connected.



- > Touch the icon «Embroidery hoop display/Embroidery hoop selection».
- > Remove the hoop.



- > Touch the icon «Move the module for the sewing mode».



> Touch the icon «Home».



> Touch the icon «Sewing mode».

Grid on/off

When the center of the hoop and the grid are displayed, the embroidery motif can be positioned more exactly.



> Touch the icon «Embroidery hoop display/Embroidery hoop selection».

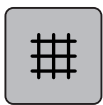

> Touch the icon «Grid on/off» to display the center of the hoop on the display.

> Touch the icon «Grid on/off» again to display the grid.

> Touch the icon «Grid on/off» again so that the center of the hoop and the grid disappear.

Locating the center of the embroidery motif

The embroidery hoop is positioned so that the needle is exactly above the center of the embroidery motif or the motif begin.



> Touch the icon «Embroidery hoop display/Embroidery hoop selection».



> Touch the icon «Center of the embroidery motif» to position the hoop so that the needle is placed exactly over the center of the embroidery motif.

> Touch the icon «Center of the embroidery motif» again to position the hoop so that the needle is placed exactly over the motif start.

Virtual positioning of the embroidery hoop

The embroidery hoop is automatically moved to the new position as soon as the embroidery motif is repositioned. Therefore, the icon «Virtual positioning» is activated automatically and outlined in yellow when an embroidery hoop is attached.

Prerequisite:

- The hoop is attached.



> Touch the icon «Embroidery hoop display/Embroidery hoop selection».



> Touch the icon «Virtual positioning» to deactivate the automatic movement of the hoop when having repositioned the embroidery motif.

– The icon «Virtual positioning» is not outlined in yellow.

> Touch the icon «Virtual positioning» again to activate the automatic movement of the hoop when having repositioned the embroidery motif.

14 Setup Program

14.1 Adjusting the embroidery settings in the Setup Program

Further information about this topic (see page 49).

15 Creative embroidering

15.1 Overview embroidering

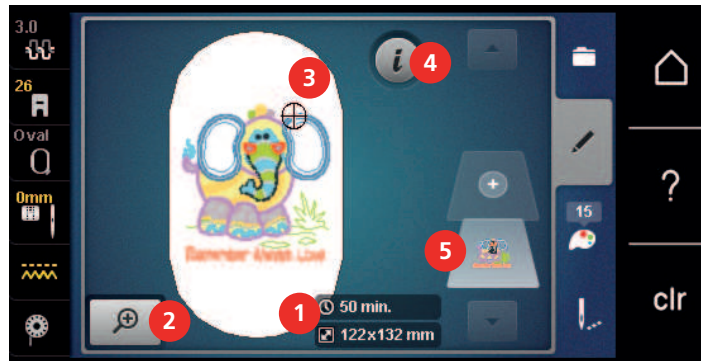

- | | | | |
|---|---|---|-------------------------|
| 1 | Embroidery time/Embroidery motif size in mm or inch | 4 | «i»-Dialog |
| 2 | Scaling up, downsizing and moving the embroidery motif view | 5 | Embroidery motif layers |
| 3 | Area to be embroidered | | |

15.2 Selecting and changing the embroidery motif

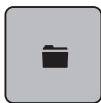

- > Touch the icon «Selection».



- > Touch the icon «Upload embroidery motif».
- > Select a new embroidery motif.

15.3 Checking the embroidery time and the embroidery motif size

In the display «Edit» at lower right (1), the estimated embroidery time is indicated in minutes and the width and height of the embroidery motif is indicated in millimeters.

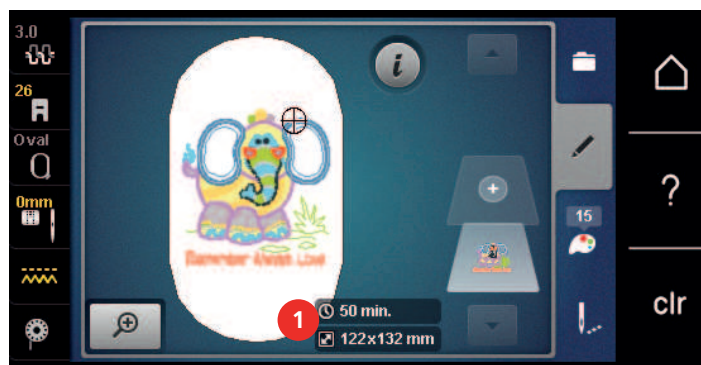

15.4 Regulating the speed

The sewing speed can be adjusted infinitely variable with the slide.

- > Move the slide to the left to reduce the sewing speed.
- > Move the slide to the right to increase the sewing speed.

15.5 Editing the embroidery motif

Overview Editing embroidery motif

- > To edit an embroidery motif, select the embroidery motif.
- > Touch the icon «i»-Dialog.



- | | | | |
|---|--------------------|----|---|
| 1 | Zoom out | 8 | Mirror image left/right |
| 2 | Zoom in | 9 | Mirror image up/down |
| 3 | Moving the view | 10 | Duplicating |
| 4 | Moving the motif | 11 | Deleting |
| 5 | Moving the motif | 12 | Checking the motif size |
| 6 | Rotating the motif | 13 | Altering the stitch type/stitch density |
| 7 | Changing the size | | |

Scaling up the embroidery motif view

The view of the embroidery motif can be scaled up. In addition to that, the view can be adjusted with or without changing the embroidery position.

- > Select an embroidery motif.
- > Touch the icon «Zoom in» to edit the view of the embroidery motif.



- > Touch the icon «Zoom in» 1 to 4 times to enlarge the view of the embroidery motif gradually.



- > Touch the icon «Zoom out» 1 to 4 times to get back to the Edit Mode.

Downsizing the embroidery motif view

The view of the embroidery motif can be downsized. In addition to that, the view can be adjusted with or without changing the embroidery position.



- > Select an embroidery motif.
- > Touch the icon «Zoom in» to edit the view of the embroidery motif.



- > Touch the icon «Zoom out» 1 to 4 times to downsize the view of the embroidery motif gradually.



Moving the embroidery motif view

The view of the embroidery motif can be moved. In addition to that, the view can be adjusted with or without changing the embroidery position.

- > Select an embroidery motif.
-  > To activate the icon «Move the view», touch the icon «Zoom in».
- 
 - The icon «Move the view» is active (dark grey)
- > Move the view of the embroidery motif.
 - The embroidery position is not altered.
-  > Touch the icon «Zoom out» to get back to the Edit Mode.

Moving the embroidery motif in enlarged view

The view of the embroidery motif can be moved. In addition to that, the view can be adjusted with or without changing the embroidery position.

- > Select an embroidery motif.
-  > To display the icon «Move the embroidery motif», touch the icon «Zoom in».
-  > Touch the icon «Move the stitch pattern».
 - The icon turns dark gray.
- > Move the view of the embroidery motif.
 - The embroidery position is altered.
-  > Touch the icon «Zoom out» to get back to the Edit Mode.

Moving the embroidery motif

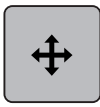
- > Select an embroidery motif.
-  > Touch the icon «i»-Dialog.
-  > Touch the icon «Move the stitch pattern».
 - > Turn the «Upper Multifunction knob» to move the embroidery motif horizontally in 1/10-mm steps.
 - > Turn the «Lower Multifunction knob» to move the embroidery motif vertically in 1/10-mm steps or
 - > touch the embroidery motif, keep it pressed and move it as you like.
 - The relocation is indicated in the yellow-framed icons.

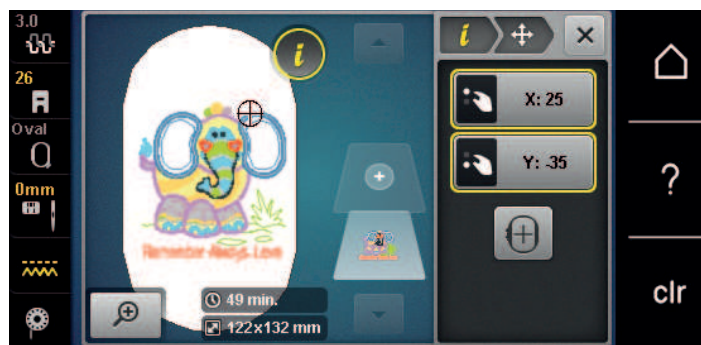

-  > Touch the icon «Center of the embroidery motif».
 - The embroidery motif is repositioned in the center of the embroidery hoop.

Rotating motif

- > Select an embroidery motif.



> Touch the icon «i»-Dialog.

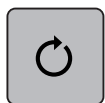

> Touch the icon «Rotate the motif».

> Turn the «Upper Multifunctional knob» or the «Lower Multifunctional knob» to the right to rotate the embroidery motif clockwise.

> Turn the «Upper Multifunctional knob» or the «Lower Multifunctional knob» to the left to rotate the embroidery motif counter-clockwise.



> Touch the icon «Rotate the motif +90°» to rotate the embroidery motif in 90°-steps.

Altering the embroidery motif size proportionally



Enlargements or reductions of the motif size up to maximum 20% achieve the best results.

If the motif size is to be altered by more than 20%, the motif should be adapted in a separate embroidery software and then reloaded onto the machine.



> Select an embroidery motif.

> Touch the icon «i»-Dialog.



> Touch the icon «Alter the embroidery size».



> To change the embroidery motif size proportionally, the icon «Retain proportions» must have a white frame.

Only touch the icon «Retain proportions» when the icon does not have a white frame.

– The icon «Retain proportions» has a white frame.



> Turn the «Upper/Lower Multifunction knob» to the right to scale up the embroidery motif proportionally.

> Turn the «Upper/Lower Multifunction knob» to the left to downsize the embroidery motif proportionally.

Altering the embroidery motif size disproportionately



Enlargements or reductions of the motif size up to maximum 20% achieve the best results.

If the motif size is to be altered by more than 20%, the motif should be adapted in a separate embroidery software and then reloaded onto the machine.

> Select an embroidery motif.



> Touch the icon «i»-Dialog.



> Touch the icon «Alter the embroidery size».



> To change the embroidery motif size disproportionately, the icon «Retain proportions» must not have a white frame.

Only touch the icon «Retain proportions» when the icon has a white frame.

– The icon «Retain proportions» does not have a white frame.

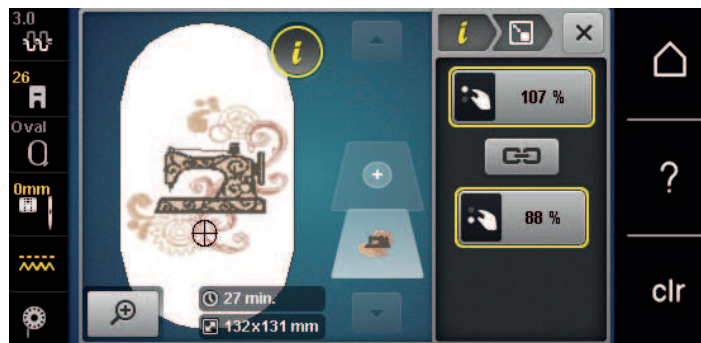

- > To make the embroidery motif wider, turn the «Upper multifunction knob» clockwise.
- > To make the embroidery motif narrower, turn the «Upper multifunction knob» anti-clockwise.
- > To make the embroidery motif longer, turn the «Lower multifunction knob» clockwise.
- > To make the embroidery motif shorter, turn the «Lower multifunction knob» anti-clockwise.

Mirroring embroidery motifs

Embroidery motifs can be mirror-imaged both vertically and horizontally.



> Select an embroidery motif.

> Touch the icon «i»-Dialog.



> Touch the icon «Mirror image left/right» to mirror the embroidery motif vertically.



> Touch the icon «Mirror image up/down» to mirror the embroidery motif horizontally.

Bending the text

Texts can be arranged and designed arc-shaped.



> Create an alphabet embroidery motif.

> Touch the icon «i»-Dialog.



> Touch the icon «Bend text».

> Turn the «Upper Multifunctional knob» to alter the distance between the characters in millimeter-steps.

> Turn the «Lower Multifunctional knob» to the left or to the right to bend the lettering upwards or downwards.

Changing the stitch type

If the satin stitches are too long, they can be changed to step stitches.

- > Select an embroidery motif.
- > Touch the icon «i»-Dialog.



- > Touch the icon «Change the stitch type».



- > Touch the switch in the upper section of the display (1) to change the satin stitch to the step stitch.
- > Adjust the desired stitch length (2) with the icons «-» or «+».

Altering the stitch density

If the satin stitches are embroidered too densely, the stitch density can be adjusted.

- > Select an embroidery motif.
- > Touch the icon «i»-Dialog.



- > Touch the icon «Change the stitch type».
- > Adjust the desired stitch density (1) with the icons «-» or «+».



Checking the size and the position of the embroidery motif

It can be checked whether or not the embroidery motif matches the designated position/location on the fabric. Points which are beyond the embroidery hoop are not traveled to.

- > Select an embroidery motif.
- > Touch the icon «i»-Dialog.



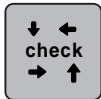

- > Touch the icon «Check embroidery motif size».
 - The embroidery hoop travels all the way until the needle is at the position as it is indicated in the display.
- > Touch the icon «Corner top left» to select the top left corner of the embroidery motif.
 - The embroidery hoop travels all the way until the needle is at the position as it is indicated in the display.
- > Touch the icon «Corner top right» to select the top right corner of the embroidery motif.
 - The embroidery hoop travels all the way until the needle is at the position as it is indicated in the display.
- > Touch the icon «Corner bottom left» to select the bottom left corner of the embroidery motif.
 - The embroidery hoop travels all the way until the needle is at the position as it is indicated in the display.
- > Touch the icon «Corner bottom right» to select the bottom right corner of the embroidery motif.
 - The embroidery hoop travels all the way until the needle is at the position as it is indicated in the display. If the embroidery motif hasn't been positioned correctly yet, the position can be altered via the «Upper/Lower Multifunction knobs» and the complete embroidery positions can be checked again.



- > Touch the icon «Embroidery motif center» to bring the needle to the center of the embroidery motif.
- > Turn the «Upper Multifunctional knob» to move the embroidery motif horizontally.
- > Turn the «Lower Multifunctional knob» to move the embroidery motif vertically.

Duplicating the embroidery motif

The active embroidery motif is duplicated.

- > Select an embroidery motif.
- > Touch the icon «i»-Dialog.



- > Touch the icon «Duplicate».
 - The embroidery motif (1) is duplicated (2).

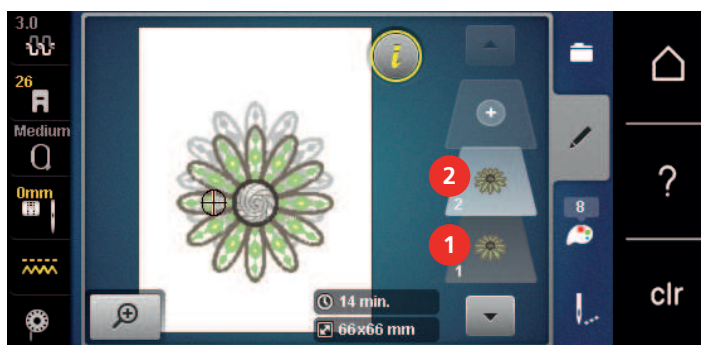

Deleting an embroidery motif

The active embroidery motif is deleted.

- > Select an embroidery motif.
- > Touch the icon «i»-Dialog.



- > Touch the icon «Delete».

15.6 Combining embroidery motifs

Combining embroidery motifs

In the Combi-Mode several embroidery motifs can be combined.

- > Select an embroidery motif.
- > Touch the icon «Add an embroidery motif» (1).
- > Select another embroidery motif.

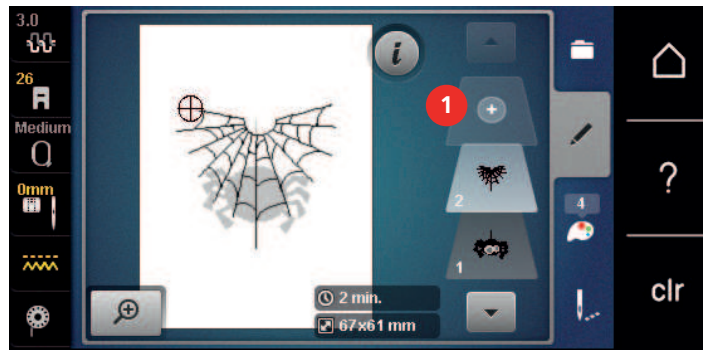

Deleting a single embroidery motif

Prerequisite:

- A combination of embroidery motifs has been created.
- > In the section of the embroidery motif level (1) touch the desired embroidery motif with the finger, keep it pressed and move it outwards.
 - A new window opens.

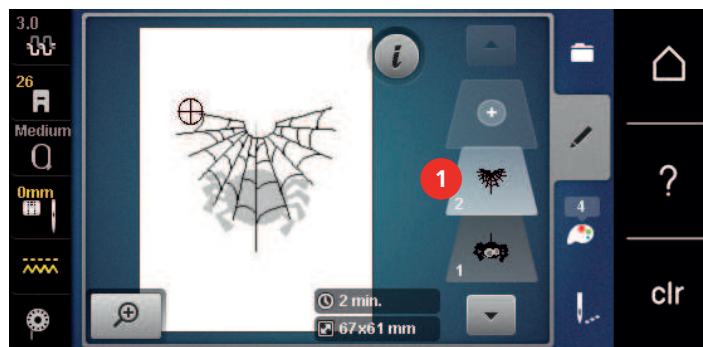

- > Touch the icon «Confirm» to delete the selected embroidery motif.

Duplicating a combination

When a combination is duplicated, the individual embroidery motifs cannot be selected anymore.

- > Select an embroidery motif.



- > Touch the icon «Add an embroidery motif».
- > Select another embroidery motif.
- > Select the combination (1).

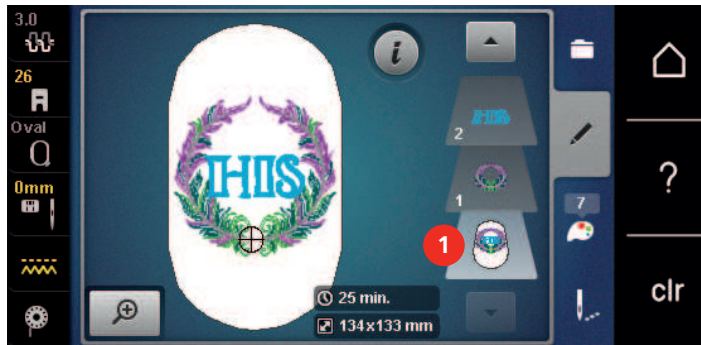

- > Touch the icon «i»-Dialog.



- > Touch the icon «Duplicate».

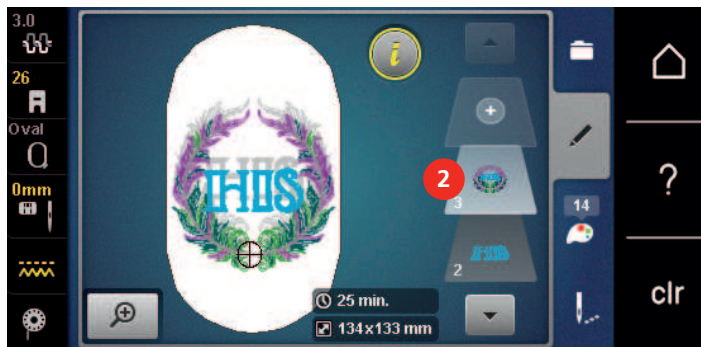

- The combination is duplicated (2).

15.7 Creating lettering

Overview embroidery alphabets

Embroidery motif	Name
ABC	Swiss Block
<i>ABC</i>	Anniversary
АБВ	Russian Textbook
ABC	Rounded Sans

Creating words/sentences



Lettering is always embroidered in one color. To embroider single letters or single words in another color, every letter or every word has to be selected individually and placed in the area to be embroidered.

Lettering can be positioned within the hoop as you like. When the embroidery motif is positioned outside the embroidering area, the hoop is outlined in red on the display. With the hoop selection it can be checked whether or not the embroidery motif can be embroidered in another hoop. When the lettering does not fit in any hoop, two single words can be combined and positioned below each other as the following example will show.



- > Select the file «Alphabets».
- > Select the font.
- > Enter the text «Made to».
- > Touch the icon (1) (standard setting) to use upper case letters.
- > Touch the icon (2) to use lower case letters.
- > Touch the icon (3) to use numbers and mathematic characters.
- > Touch the icon (4) to use special characters.



- > Touch the text box above the keyboard to delete the entered text completely.
- > Touch the icon «DEL» to delete single letters of the entered text.



- > Touch the icon «Confirm» to accept the text.



- > Touch the icon «Embroidery hoop display/Embroidery hoop selection».
- > Select the hoop.
- > Touch the icon «Embroidery hoop display/Embroidery hoop selection» again to go back to the Edit Mode.

Editing words/sentences



- > Touch the icon «i»-Dialog.



- > Touch the icon «Rotate the motif».



- > Touch the icon «+90» to rotate the text by 90°.
- > Touch the icon «i» (1).



- > Touch the icon «Move the stitch pattern».
- > Turn the «Upper Multifunctional knob» to move the embroidery motif horizontally.

- > Turn the «Lower Multifunctional knob» to move the embroidery motif vertically.



- > Touch the icon «Add motif».
- > Enter and also rotate the text «create».



- > Touch the icon «Embroidery hoop display/Embroidery hoop selection».

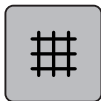

- > Touch the icon «Grid on/off» to position the text lines more exactly.

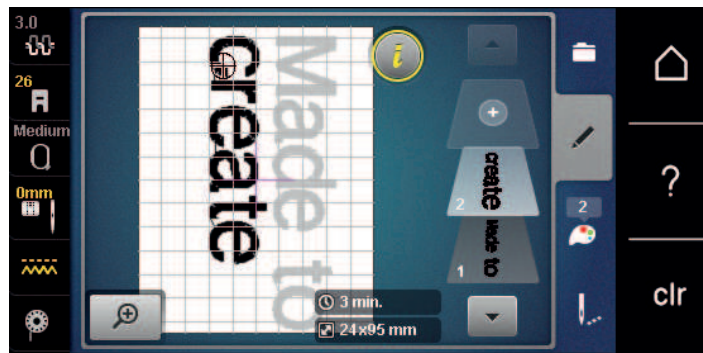

15.8 Changing the colors of the embroidery motif

Overview changing the color

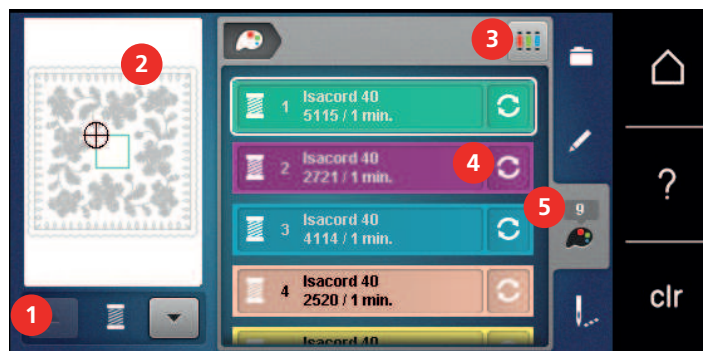

- | | | | |
|---|-----------------------------|---|----------------------|
| 1 | Colors of embroidery motifs | 4 | Altering color/brand |
| 2 | Preview for selected color | 5 | Color information |
| 3 | Allocating thread brand | | |

Changing the colors



- > Select an embroidery motif.
- > Touch the icon «Color information».

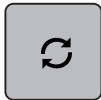

- > Touch the icon «Change color/manufacturer» beside the color that you want to change.
- > To display additional colors, swipe up or down on the display.



- > To select the color by entering the color number, touch the icon «Color selection by number».
- > Enter the number for the required color.
 - The color icon is displayed on the left.
- > To confirm the color selection, touch the color icon that is displayed on the left.

Changing the thread brand



- > Select the embroidery motif.
- > Touch the icon «Color information».

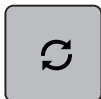

- > Touch the icon «Alter color/brand».



- > To show more thread brands, touch the icons «Scroll left» and «Scroll rights» in the upper part of the screen.



- > Touch the icon «Allocate thread brand».
 - Any thread colors of the selected embroidery motif will be matched with the selected thread brand.

15.9 Embroidering the embroidery motif

Overview Embroidery menu



- | | | | |
|---|--|---|---|
| 1 | Basting | 5 | Multi-colored embroidery motif on/off |
| 2 | Moving the hoop | 6 | Embroidery speed (appears by scrolling) |
| 3 | Embroidery sequence control when thread breaks | 7 | Reducing color changes (appears by scrolling) |
| 4 | Cutting connecting stitches | 8 | Color indication |

Adding basting stitches

The basting stitches can be embroidered along the embroidery hoop or along the embroidery motif. Therefore the connection between the fabric and the stabilizer can be improved.



- > Select an embroidery motif.
- > Touch the icon «Embroidering».

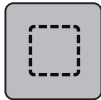

- > Touch the icon «Basting» to embroider basting stitches along the embroidery motif.
- > Touch the icon «Basting» again to embroider basting stitches along the embroidery hoop.
- > Touch the icon «Basting» again to deactivate the basting stitches.

Moving the hoop

If the embroidery motif is so big that repeated rehooping is necessary, the embroidered motif can be moved again.



- > Select an embroidery motif.
- > Touch the icon «Embroidering».



- > Touch the icon «Move the hoop».
- > Turn the «Upper Multifunctional knob» to move the hoop horizontally.
- > Turn the «Lower Multifunctional knob» to move the hoop vertically.



- > Touch the icon «Embroidering» in the process navigation to accept the settings.

Embroidery sequence control when thread breaks

When the thread breaks, the needle can be repositioned in the embroidery motif by means of the embroidery sequence control.



- > Select an embroidery motif.
- > Touch the icon «Embroidering».



- > Touch the icon «Embroidery sequence control when thread breaks».
 - In the left portion of the display a compact view of the embroidery motif is displayed. On the right side the enlarged embroidery motif is displayed.
- > Select the desired position in the compact view using the touchscreen pen/finger.
- > Turn the «Upper Multifunctional knob» to move the hoop stitch by stitch.
- > Turn the «Lower Multifunctional knob» to move the hoop in large steps.
 - The number in the yellow-framed icon indicates the number of stitches within the embroidery sequence.



- > Touch the icon «Magnifier» to select the desired stitch via entry.

Cutting connecting stitches

The function is activated by default and the connecting stitches are cut automatically. When the function is deactivated, the connecting stitches between the embroidery motifs must be cut manually.



- > Select an embroidery motif.
- > Touch the icon «Embroidering».



- > Touch the yellow-framed icon «Cut the connecting stitches» to deactivate the function.
- > Touch the icon «Cut the connecting stitches» again to activate the function.

Reducing color changes

When the embroidery motifs overlap, the color changes **cannot** be reduced.



- > Select an embroidery motif.
- > Touch the icon «Embroidering».



- > Touch the icon «Reduce thread change».
- Identical colors of the embroidery motif are collected to one color.

Multi-colored embroidery motif on/off

Multi-colored embroidery motifs can also be embroidered in one color.



- > Select an embroidery motif.
- > Touch the icon «Embroidering».

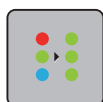

- > Touch the icon «Multi-colored embroidery motif on/off».
- The embroidery motif is embroidered in one color.

Color indication

Every color of the embroidery motif can be selected individually. The hoop moves to the first stitch of the current color. The currently active color can be embroidered individually or in another sequence.



- > Select an embroidery motif.
- > Touch the icon «Embroidering».



- > Touch the icon «Scroll down» to select the next color of the embroidery motif.



- > Touch the icon «Scroll up» to select the previous color of the embroidery motif.

15.10 Free arm embroidering

Free arm embroidering is defined as embroidering tubular fabrics or garments which are positioned around the free arm of the embroidery machine while being embroidered. Often used with sleeves, pant legs or other narrow-tailored garments.





A tubular piece of fabric can be pulled over the free arm of the machine easily when the free arm is positioned to the left in parking position before the hoop is attached or removed. Push the button «Start/ Stop» to move the embroidery hoop back to the embroidery position again.

Make sure to use a full bobbin as the embroidery hoop needs to be removed for changing the bobbin.

The movability of the embroidery arm can be limited or impeded with very narrow tubes. Therefore please make sure that the embroidery hoop can move forwards and backwards sufficiently. An impediment of the embroidery arm caused by a tube which is too tight can result in embroidery motif offset or in damaging the fabric.

Check the movability of the free arm

- > Open the embroidery motif on the machine and edit as desired.
- > Mark the embroidery motif position and the size on the fabric in a suitable way.
- > Select the embroidery hoop as small as possible.
- > Hoop or stick the fabric along with the appropriate stabilizer in the embroidery hoop, depending on the stabilizer.
- > Pull the fabric tube carefully over the free arm of the machine and attach the embroidery hoop at the clutch of the embroidery module.
- > If necessary, reposition the embroidery motif.
- > Previously check whether the embroidery hoop can be moved forwards and backwards according to the embroidery motif size.
- > Touch the icon «Check embroidery motif size».
- > After the successful check of the embroidery motif size, start the embroidery process.
 - You can find detailed instructions about embroidery, how to use appropriate materials or how to select the required embroidery settings on the machine in the «Tutorial» under embroidery techniques --> Embroidery.

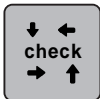

15.11 Administering embroidery motifs

Administering embroidery motifs



- | | | | |
|---|------------------------------|---|----------|
| 1 | Loading the embroidery motif | 3 | Deleting |
| 2 | Saving the embroidery motif | | |

Saving embroidery motifs in the personal memory

In the filing system «Personal memory» any stitch patterns, also those which have been individually edited, can be saved.

- > Select an embroidery motif.
- > Edit the embroidery motif.



> Touch the icon «Selection».



> Touch the icon «Save the motif».
– The embroidery motif to be saved is outlined in yellow.



– The icon «Embroidery machine» is activated.



> Touch the icon «Confirm».

Saving the embroidery motif on the BERNINA USB stick

- > Select an embroidery motif.
- > Edit the embroidery motif.
- > Touch the icon «Selection».



> Touch the icon «Save the motif».
– The embroidery motif to be saved is outlined in yellow.

> Insert the BERNINA USB stick into the USB port of the machine.



> Touch the icon «USB stick».



> Touch the icon «Confirm».

Overwriting the embroidery motif in the personal memory

- > Select an embroidery motif.
- > Edit the embroidery motif.
- > Touch the icon «Selection».



> Touch the icon «Save the motif».
– The embroidery motif to be saved is outlined in yellow.

– Touch the icon «Embroidery machine» is activated.



> Select the embroidery motif which is to be overwritten.



> Touch the icon «Confirm».

Overwriting the embroidery motif on the BERNINA USB stick

- > Select an embroidery motif.
- > Edit the embroidery motif.
- > Touch the icon «Selection».



> Touch the icon «Save the motif».
– The embroidery motif to be saved is outlined in yellow.

> Insert the BERNINA USB stick into the USB port of the machine.



> Touch the icon «USB stick».

> Select the embroidery motif which is to be overwritten.



> Touch the icon «Confirm».

Importing stitch patterns

Stitch patterns or stitch pattern combinations can be imported from the Sewing mode to the Embroidery mode and edited like embroidery motifs. Therefore endless embroidery can be combined quickly and easily and saved as an embroidery motif in the file «Personal embroidery motifs».



> Touch the icon «Home».



> Touch the icon «Sewing mode».
> Select a stitch pattern.



> Touch the icon «Home».



> Touch the icon «Embroidery mode».
– The stitch pattern is saved automatically in the file «Personal embroidery motifs».



> Select the file «Personal embroidery motifs».
> Select an embroidery motif.

Loading an embroidery motif from the personal memory

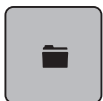

> Touch the icon «Selection».



> Touch the icon «Upload embroidery motif».



> Select the file «Personal embroidery motifs».
> Select an embroidery motif.

Loading an embroidery motif from the BERNINA USB stick

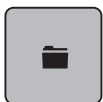

> Touch the icon «Selection».
> Insert the BERNINA USB stick into the USB port of the machine.



> Touch the icon «USB stick».
> Select a personal embroidery motif.

Deleting an embroidery motif from the personal memory

The embroidery motifs which are saved in the personal memory can be deleted individually.



> Touch the icon «i»-Dialog.



> Touch the icon «Delete».



– Touch the icon «Embroidery machine» is activated.

> Select the embroidery motif which is to be deleted.



> Touch the icon «Confirm».

Deleting an embroidery motif from the BERNINA USB stick



> Touch the icon «Selection».



> Touch the icon «Delete».

> Insert the BERNINA USB stick into the USB port of the machine.



> Touch the icon «USB stick».

> Select the embroidery motif which is to be deleted.



> Touch the icon «Confirm».



16 Embroidery

16.1 Embroidering via the button «Start/Stop»

In case of a power cut the embroidery process is interrupted. After the restart the machine goes to the position which was embroidered last.



- > Push the button «Start/Stop» to start the embroidery machine.
 - The machine will stop after about 7 stitches.
- > Raise the embroidery foot.
- > Cut the bobbin thread according to the animation in the display and touch the icon «OK» to confirm.

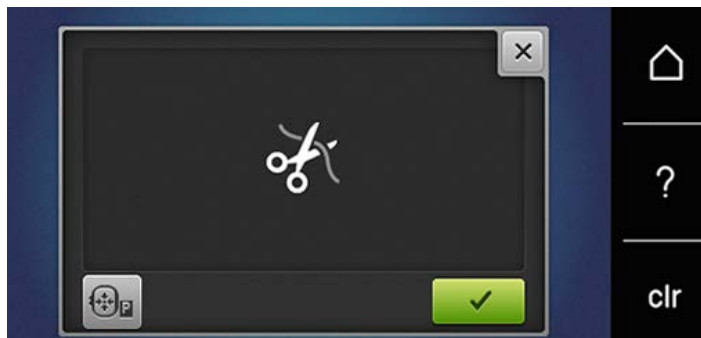

- > Lower the embroidery foot.
- > Press the button «Start/Stop» to continue embroidering.

16.2 Increasing the embroidery speed

To ensure the best embroidery quality, the speed when embroidering is reduced depending on the embroidery position. Choose between the two options to either embroider at optimal or maximum speed. Standard = optimal speed. It has to be considered that the quality of the embroidered embroidery motif at maximum speed cannot be ensured.

By switching the machine off and on, the optimal embroidery speed is activated.

Prerequisite:



- The embroidery motif is selected.
- > Touch the icon «Embroidery speed».
 - The maximum speed is activated.
- > Touch the icon «Embroidery speed» again.
 - The optimal speed is activated.

16.3 Adjusting the upper thread tension

The basic setting of the upper thread tension is provided automatically as soon as a stitch pattern or an embroidery motif is selected.

The upper thread tension is set optimally at the BERNINA factory and the machine has been tested. Metrosene-/Seralon thread size 100/2 (Company Mettler, Switzerland) is used for upper and bobbin thread.

When of using other types of sewing or embroidery threads, the optimal tension may vary. Therefore it may be necessary to adjust the upper thread tension according to the sewing or embroidering project as well as the desired stitch pattern or the embroidery motif individually.

The higher the upper thread tension, the tighter the upper thread which means that the bobbin thread is pulled up to the top of the fabric. When the upper thread tension is low, the upper thread is less tightened which means that the bobbin thread is pulled up less.

Alterations of the upper thread tension affect the currently selected stitch pattern or embroidery motif. Permanent alterations of the upper thread tension for the sewing mode (see page 47) and for the embroidering mode (see page 49) can be made in the Setup Program.

Prerequisite:

- In the Setup Program the upper thread tension has been altered.
- > Touch the icon «Upper thread tension».
- > Move the slide using the touchscreen pen/finger to increase or reduce the upper thread tension.



- > Touch the yellow-framed icon on the right side to reset the alteration to default setting.
- > Touch the yellow-framed icon on the left side to reset the alteration to default setting in the **Setup Program**.

16.4 Embroidering via the foot control

Embroidering via the foot control is recommended when only a short sequence has to be embroidered. While embroidering, the foot control must be pressed down all the time.

- > Press the foot control to start embroidering.

17 Appendix

17.1 Maintenance and cleaning

Cleaning the display

- > Clean the display in the switched off status with a soft slightly damp microfiber cloth.

Cleaning the feed dog

Remove the thread remnants under the stitch plate regularly.



Electronically driven components

Risk of injury near the needle and the hook.

- > Raise the presser foot.
- > Switch the machine off and disconnect it from the power supply system.

- > Remove the presser foot and the needle.
- > Lower feed dog.



- > Remove the stitch plate.
- > Clean the feed dog with the brush.

Cleaning the hook



Electronically driven components

Risk of injury near the needle and the hook.

- > Switch the machine off and disconnect it from the power supply system.

- > Open the bobbin cover.
- > Remove the bobbin case.
- > Push the fastening bracket to the left.

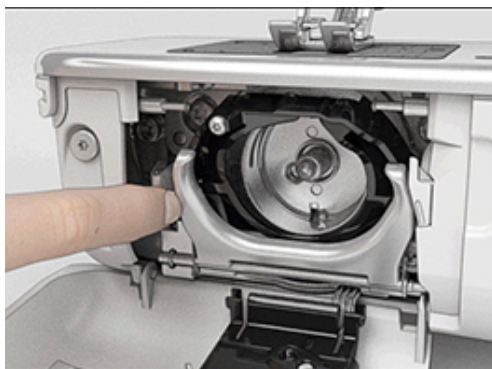

- > Flap down the fastening bracket along with the black hook race cover.
- > Remove the hook.

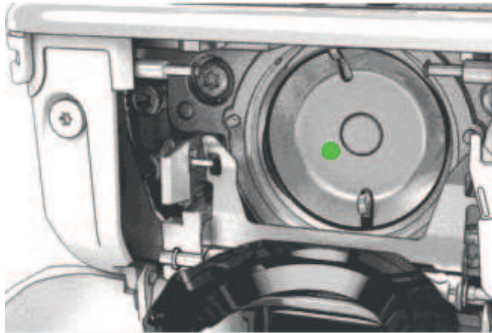

- > Clean the hook race area with the brush; never use a sharp instrument.
- > Hold the hook at the pin in the center with two fingers.
- > Lead the hook, lower edge ahead, angular top-down behind the hook race cover.
- > Position the hook with the two lugs meeting the openings in the hook, the colored mark on the hook driver should be visible through the hole in the hook.
- > Insert the hook.
 - The hook is magnetic and therefore fastened to the correct position.
- > Close the hook race cover and the fastening bracket until the release bracket engages.
- > As a check, turn the handwheel.
- > Insert the bobbin case.

Lubricating the hook



CAUTION

Electronically driven components

Risk of injury near the needle and the hook.

- > Switch the machine off and disconnect it from the power supply system.

NOTICE

Lubricating the hook

Too much oil can pollute the fabric and the thread.

- > After lubricating, sew/embroider a test piece first.

- > Remove the bobbin case.
- > Push the fastening bracket to the left.

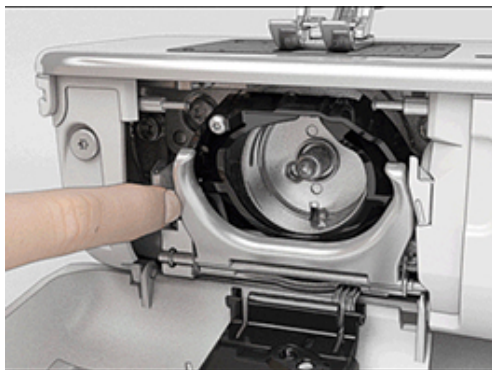



- > Flap down the fastening bracket along with the black hook race cover.





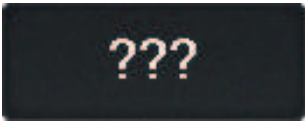
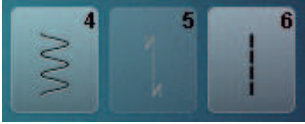

17.2 Troubleshooting

Fault	Cause	Solution
Uneven stitch formation	Upper thread too tight or too loose.	> Adjust the upper thread tension.
	Needle blunt or bent.	> Replace the needle, make sure that a new BERNINA quality needle is used.
	Poor quality needle.	> Use a new BERNINA quality needle.
	Poor quality thread.	> Use quality thread.
	Incorrect needle/thread combination.	> Match the needle with the thread size.
	Incorrectly threaded.	> Rethread.
	The fabric has been pulled.	> Feed the fabric evenly.
Uneven stitch formation	Incorrect bobbin case is used.	> Use the supplied bobbin case with triangles.
		
Skipped stitches	Incorrect needle.	> Use the needle system 130/705H.
	Needle blunt or bent.	> Replace the needle.
	Poor quality needle.	> Use a new BERNINA quality needle.
	The needle is incorrectly inserted.	> Insert the needle with the flat side to the back as far up as it will go into the needle holder and tighten the screw.
	Incorrect needle point.	> Match the needle point to the texture of the material.
Faulty stitching	Thread remnants between the thread tension discs.	> Fold a piece of thin material and slide the folded edge (not the raw edges) between the thread tension discs.
	Incorrectly threaded.	> Rethread.
	Thread remnants below the bobbin case spring.	> Remove the thread remnants under the spring.

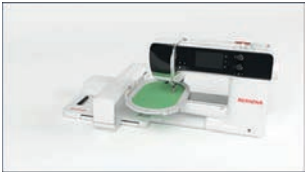
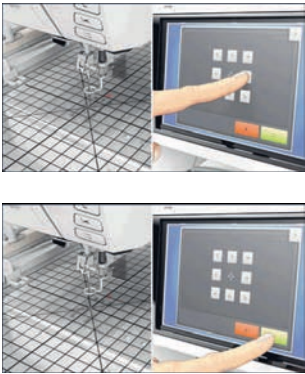

Fault	Cause	Solution
The machine doesn't start	Unfavorable room temperature.	> Place the machine in a warm room one hour before use. > Connect the machine and switch it on.
	The machine is damaged.	> Contact the specialized BERNINA dealer.
Neither the sewing light nor the light on the free arm lights up	Settings in the Setup Program.	> Activate it in the Setup Program.
	The sewing light is defect.	> Contact the specialized BERNINA dealer.
Upper thread indicator doesn't react	Settings in the Setup Program.	> Activate it in the Setup Program.
	The upper thread indicator is defect.	> Contact the specialized BERNINA dealer.
Error during software update	USB stick is not recognized.	> Use a BERNINA USB stick.
	The update process is blocked and the hourglass on the display is inactive.	> Remove the USB stick. > Switch the machine off. > Switch the machine on. > Follow the instruction on the display.
	Date of the software update cannot be found.	> Unzip the update data. > Save data of the software update directly on the data medium and not in a file on the USB stick.
BSR presser foot #42 not detected	Lens is dirty.	> Clean the lens with a soft, slightly damp cloth.
	BSR cable not inserted correctly.	> Insert the BSR connector vertically until you feel it click into place.

17.3 Error messages

Message on the display	Cause	Solution
	Stitch number unknown.	> Check the entry and enter the new number.
	Selection of the stitch pattern not possible in the combi mode.	> Combine other stitches.
	The feed dog is not lowered.	> Push the button «Feed dog up/down» to lower the feed dog.

Message on the display	Cause	Solution
	The selected needle and stitch plate cannot be used in combination.	<ul style="list-style-type: none"> > Replace the needle. > Replace the stitch plate.
	The needle is not at its top end.	<ul style="list-style-type: none"> > Adjust the needle position via the handwheel.
	The upper thread is used up.	<ul style="list-style-type: none"> > Rethread.
	The upper thread has broken.	<ul style="list-style-type: none"> > Rethread.
	The main motor isn't running.	<ul style="list-style-type: none"> > Turn the handwheel clockwise until the needle is at its top position. > Remove the stitch plate. > Remove the thread remnants. > Clean the hook. > Remove the hook and make sure that there are no pieces of broken needle points on the magnetic back of the hook.
	The contact between the machine and the embroidery module is interrupted due to vibrations.	<ul style="list-style-type: none"> > Make sure that the module and the machine are standing on a stable, even surface. > Connect the embroidery module to the machine.
	The needle position doesn't correspond with the center of the hoop.	<ul style="list-style-type: none"> > Calibrate the hoop.
	The embroidery module is not attached.	<ul style="list-style-type: none"> > Connect the embroidery module to the machine. > Contact the specialized BERNINA dealer to have the machine checked.

Message on the display	Cause	Solution
	The hoop is not attached.	> Attach the hoop.
	The hoop is attached.	> Remove the hoop.
	The movement of the hoop follows.	> Touch the icon «Confirm».
	Mega Hoop top.	> Bring the Mega Hoop to the top position.
	Mega Hoop center.	> Bring the Mega Hoop to the center position.
	Mega Hoop bottom.	> Bring the Mega Hoop to the lower position.
	The embroidery motif is partly outside the hoop.	> Reposition the embroidery motif and start embroidering it again.

Message on the display	Cause	Solution
	The embroidery motif is too large.	<ul style="list-style-type: none"> > Reduce the size of the embroidery motif. > Attach a larger embroidery hoop.
Too less free capacity on the BERNINA USB stick (optional accessory).	Not enough free capacity on the BERNINA USB stick (optional accessory).	<ul style="list-style-type: none"> > Make sure that the BERNINA USB stick (optional accessory) is used. > Delete data from the BERNINA USB stick (optional accessory).
No personal data on the BERNINA USB stick (optional accessory).	No personal data for recovery available on the BERNINA USB stick (optional accessory).	<ul style="list-style-type: none"> > Make sure that the data and settings have been saved on the BERNINA USB stick (optional accessory).
The recovery of personal data has failed.	The software update has been successful but the personal data couldn't be recovered.	<ul style="list-style-type: none"> > Make sure that the data and settings have been saved on the BERNINA USB stick (optional accessory). > Transfer saved data to the machine.
No BERNINA USB stick is inserted. Make sure that during the complete automatic update always the same BERNINA USB stick remains inserted.	The BERNINA USB stick (optional accessory) is not inserted.	<ul style="list-style-type: none"> > Use a BERNINA USB stick (optional accessory) providing enough free capacity.
The update of the software has failed.	The latest software version cannot be found on the USB stick.	<ul style="list-style-type: none"> > Make sure that the compressed zip file has been unzipped for the software update. > Check whether the data for the software update are saved directly on the data medium and not in a file on the USB stick. > Update the software.
 	The machine needs cleaning/ lubricating.	<ul style="list-style-type: none"> > Clean the machine. > Lubricate the hook. <p>Important information on lubricating: Too much oil can pollute the fabric and the thread.</p> <ul style="list-style-type: none"> > After lubricating, sew/embroider a test piece first.

Message on the display	Cause	Solution
The automatic thread cutter (at the thread catcher) needs cleaning.	The automatic thread cutter needs cleaning. The message appears every time when the machine is started as soon as 1000 cutting cycles have been carried out.	<ul style="list-style-type: none"> > Touch the icon «Confirm». <ul style="list-style-type: none"> – The machine calls up the function «Clean the thread catcher». > Clean the thread catcher according to the instructions on the display. <ul style="list-style-type: none"> – The counter for the cutting cycles is reset.
It is time for the regular maintenance. Please contact your specialized BERNINA dealer to make an appointment.	<p>The machine needs maintenance. The message appears after the programmed service interval has expired.</p> <p>Important information: Having your machine cleaned and serviced properly at the appropriate times ensures its proper functioning and a long service life. Ignoring the terms can affect the operating life and restrict the guaranteeing. The cost allocation for maintenance work is regulated nationally. Consult your specialised dealer or your servicing shop for more details.</p>	<ul style="list-style-type: none"> > Contact the specialized BERNINA dealer. > Delete the message temporarily by touching the icon «ESC». <p>Having cleared the message three times, the message will appear as recently as the next service interval has been completed.</p>

17.4 Storage and disposal

Storing the machine

It is recommended to store the machine in the original packaging. If the machine is stored in a cold room, place it in a warm room one hour before use.

- > Switch the machine off and disconnect it from the power supply system.
- > Don't store the machine outdoor.
- > Protect the machine against climatic influences.

Dispose of the machine

- > Clean the machine.
- > Sort the components by their materials and dispose of them according to the local laws and regulations.

17.5 Technical data

Designation	Value	Unit
Maximum fabric thickness	10.5 (0.41)	mm (inch)
Sewing light	12 to 16	LED

Designation	Value	Unit
Maximum speed	1000	Stitches per minute
Measurements without the spool pin (W x H x D)	465 x 330 x 200 (18.30 x 12.99 x 7.87)	mm (inch)
Weight	11.5	kg
Energy consumption	90	W
Input voltage	100 – 240	V
Protection class (Electrical engineering)	II	
Production date: To be seen on the type label under «Code».		

18 Overview stitch patterns

18.1 Overview Stitch patterns

Practical stitches

1	2	3	4	5	6	7	8	9	10	11
12	13	14	15	16	17	18	19	20	22	23
24	25	26	29	30	32	33	34			

Buttonholes

51	52	53	54	55	56	57	59	63	64	66
69	60	61	62							

Decorative stitches

Natural stitches

101	102	103	104	106	107	108	109	110	111	112
113	114	115	116	117	118	119	122	123	124	125
129	130	131	132	137	138	139	140	141	142	143



144	145	150	152	153	154	155	156	167	168	169
170										

Cross stitches

301	302	303	304	305	306	307	308	309	319	320
321	322	323	324	325	326	327	328	329	330	331
332	333	334	335	336	337	338	339			

Satin stitches

401	402	405	406	407	408	409	410	412	413	414
415	416	417	418	419	421	422	423	424	425	426
427	428	429	433	434	453	454	455	456	465	466

Ornamental stitches

601	602	603	604	605	606	607	608	609	610	611
612	613	614	615	616	618	619	620	621	622	623

624	625	626	627	628	629	630	631	633	634	635
637	639	640	641	642	643	644	645	646	647	648
649	650	651	652	653	654	655	656	657	658	660
661	662	663	665	666						

Heirloom stitches

701	702	703	704	705	706	707	708	709	710	711
712	713	714	715	716	717	721	722	723	724	725
726	727	729	730	731	732	733	734	735	736	737
739	741	742	743	744	745	748	749	750	751	752
770	771	772	773	774	775	776	777	778		

Novelty

901	902	903	904	905	906	907	908	909	910	911

912	913	914	915	916	917	918	919	920	921	922
924	926	928	935	938	939	940	944	945	946	948
950	954	961								

Quilt stitches

1301	1302	1303	1304	1305	1306	1307	1308	1309	1310	1311
1312	1313	1314	1315	1316	1317	1318	1319	1320	1321	1322
1323	1324	1325	1326	1327	1329	1330	1331	1332	1333	1334
1335	1336	1337	1338	1339	1340	1341	1342	1344	1345	

18.2 Overview Embroidery motifs







Editing embroidery motifs

Let your creativity run free. A vast selection of embroidery motifs is at your disposal.





If one of the following pictograms is under the embroidery motif number, you can find additional information at

www.bernina.com/specialeffects.



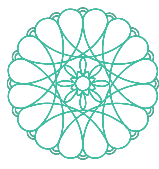
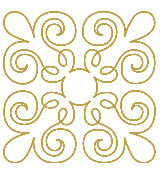
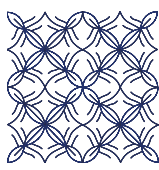

	Detached point		Punchwork Design (motif)
	Hole embroidery		Cord embroidery
	Fringe embroidery		Projects in the hoop

	Appliqué		Puffy fonts
	CutWork Design (motif)		Quilting
	PaintWork Design (motif)		Trapunto
	CrystalWork Design (motif)		





Quilt motifs

No.	Embroidery motif Colors	Width x Height > mm > inch	No.	Embroidery motif Colors	Width x Height > mm > inch
BD804	 ■	122 x 123 4.80 x 4.84	12499-06	 ■	101 x 101 3.98 x 3.98
12416-04	 ■	89 x 89 3.50 x 3.50	NZ498	 ■	89 x 88 3.50 x 3.50
12380-22	 ■	110 x 60 4.33 x 2.36	BD299	 ■	94 x 95 3.70 x 3.74
BD501	 ■	63 x 61 2.48 x 2.40			













Ornaments

No.	Embroidery motif Colors	Width x Height > mm > inch	No.	Embroidery motif Colors	Width x Height > mm > inch
NB251	 ■ ■ ■ ■	71 x 103 2.80 x 4.05	NB826-48	 ■ ■ ■ ■	134 x 133 5.28 x 5.20
80090-06 	 ■ ■ ■ ■	83 x 37 3.27 x 1.46	21021-04	 ■ ■ ■ ■	123 x 150 4.84 x 5.91













Flowers



No.	Embroidery motif Colors	Width x Height > mm > inch	No.	Embroidery motif Colors	Width x Height > mm > inch
21009-21	 ■ ■	65 x 107 2.52 x 4.21	21027-14	 ■ ■ ■ ■ ■ ■ ■ ■ ■ ■	120 x 120 4.72 x 4.72
21002-02	 ■ ■	109 x 160 4.30 x 6.30	FQ733	 ■ ■ ■ ■ ■ ■	66 x 66 2.60 x 2.60

Children

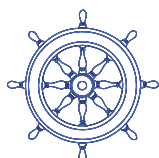











No.	Embroidery motif Colors	Width x Height > mm > inch	No.	Embroidery motif Colors	Width x Height > mm > inch
BE790313 	 	99 x 102 3.86 x 4.02	CK867 	 	122 x 132 4.80 x 5.20
BE790309 	 DOG 	87 x 149 3.43 x 5.87	BE790310 	 I LOVE YOU 	138 x 136 5.39 x 5.35

Seasons











No.	Embroidery motif Colors	Width x Height > mm > inch	No.	Embroidery motif Colors	Width x Height > mm > inch
NA614	 	102 x 101 3.98 x 3.98	21019_14 	 	123 x 130 4.84 x 5.12
NB754-48	 	114 x 128 4.49 x 5.04	12421-37	 	67 x 61 2.64 x 2.40
12421-03	 	45 x 48 1.77 x 1.89	NA617	 	96 x 96 3.78 x 3.78

No.	Embroidery motif Colors	Width x Height > mm > inch	No.	Embroidery motif Colors	Width x Height > mm > inch
12472-01 	 	137 x 141 5.39 x 5.55			









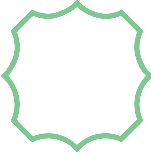

Animals

No.	Embroidery motif Colors	Width x Height > mm > inch	No.	Embroidery motif Colors	Width x Height > mm > inch
WP415-48	 	132 x 148 5.20 x 5.83	CM213-48	  	58 x 102 2.28 x 4.02
CM216-48 	 	47 x 67 1.85 x 2.64	NA248	 	77 x 73 3.03 x 2.87
CM220	 	71 x 71 2.80 x 2.80			







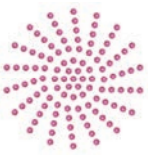

Borders and Lace

No.	Embroidery motif Colors	Width x Height > mm > inch	No.	Embroidery motif Colors	Width x Height > mm > inch
21021-25 	 	33 x 71 1.30 x 2.80	12659-06 	 	36 x 59 1.42 x 2.32
21002-21	 	21 x 151 0.83 x 5.95	FB436	 	29 x 132 1.20 x 5.20

Frames and borders

No.	Embroidery motif Colors	Width x Height > mm > inch	No.	Embroidery motif Colors	Width x Height > mm > inch
12611-27 	 	136 x 137 5.35 x 5.39	12649-05 	 	91 x 88 3.58 x 3.47
32078-04 	 	123 x 173 4.84 x 6.81	NZ195	 	76 x 76 2.99 x 2.99

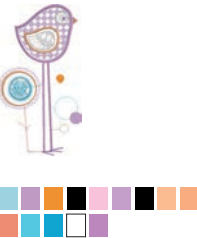
Designs with special effects

No.	Embroidery motif Colors	Width x Height > mm > inch	No.	Embroidery motif Colors	Width x Height > mm > inch
DW11 		70 x 71 2.76 x 2.80	12448-09_ PW 	 	121 x 161 4.80 x 6.30
21022-13_ DW  		106 x 192 4.13 x 7.56	DW05 		105 x 94 4.13 x 3.70

S

Safety instructions	9
Saving a stitch pattern combination	70
Saving the service data	58
Select own settings	54
Selecting a stitch pattern	66
Selecting an embroidery motif	128
Selecting the language	56
Setting the display brightness	56
Setting the maximum sewing speed	47
Setting the securing stitches	47
Setting the sewing light	56
Setting the sounds	55
Setting the upper thread indicator	55
Sewing a test sample	107
Storing the machine	168

T

Technical specifications	168
Threading the bobbin thread	44
Threading the double needle	42
Threading the triple needle	43
Threading the upper thread	40
Troubleshooting	162

U

Updating the machine firmware	61
Upper thread tension	49, 157
Using eco mode	65
Using the spool net	33

V

Virtual positioning of the embroidery hoop	137
--	-----





in partnership with

Mettler[®]

BERNINA International AG | CH-8266 Steckborn Switzerland | www.bernina.com | © Copyright by BERNINA International AG

1028855_10A_04
2019-09 EN

made to create **BERNINA**