

BERNINA

nova

Operating Instructions

900

electronic

List of Contents

Parts of the machine	3	Thread tension	17
Opening of case	5	Attachment table	18
Removal of two halves of case	6	Changing the presser foot	19
Electrical equipment	8	Needle position	20
Sewing lamp	9	Straight stitch sewing	21
Bobbin case and bobbin	10	Reverse sewing	21
Needle and thread table	11	Stitch length – satin stitch	22
Winding bobbin thread	12	Zigzag sewing	22
Inserting bobbin in case	13	Utility stitches	23
Placing case with bobbin in hook	13	Automatic buttonhole sewing	24
Inserting the needle	14	Cleaning and oiling	27
Threading the upper thread	15	Safety instructions	28
Bringing up the bobbin thread	16	Faults	29
Lowering the feed dog	16		

Important note (safety regulations – BEAB, OSHA etc.)

Please observe the sewing position while sewing. The moving needle is a source of danger (danger of injury to fingers).

The sewing machine should be disconnected from the power supply by pulling out the plug from the socket when changing the light bulb, the needle, presser foot, bobbin or needle plate, when stopping work without supervision and during servicing (cleaning).

BERNINA

Name: _____

Address: _____

Date of delivery: _____

Machine No. _____

Model 900 Free-arm zigzag sewing machine with 6 built-in utility stitches
and automatic buttonholer

Fritz Gegauf Ltd., Bernina Sewing Machine, Steckborn TG / Switzerland

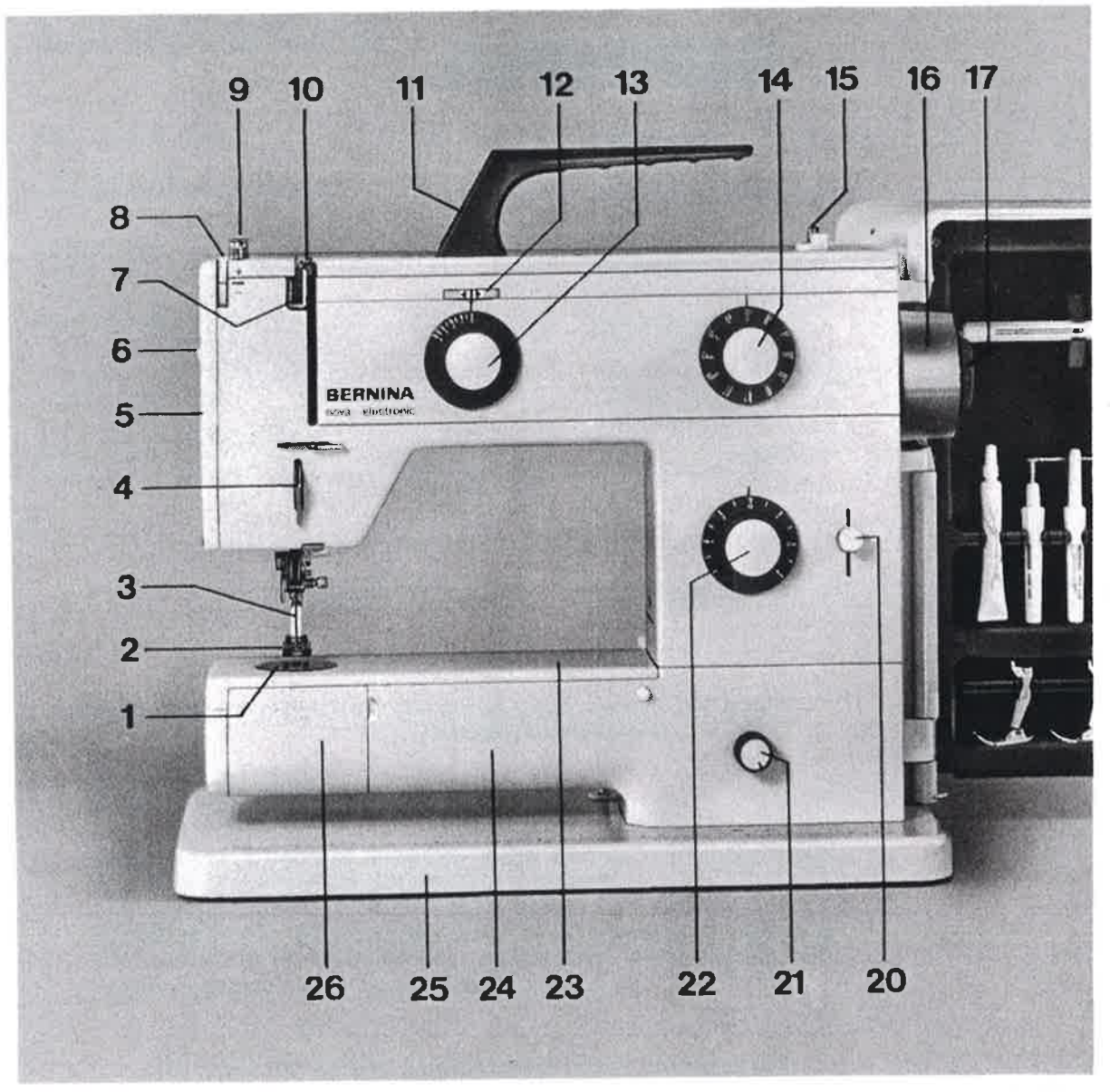

Parts of the machine

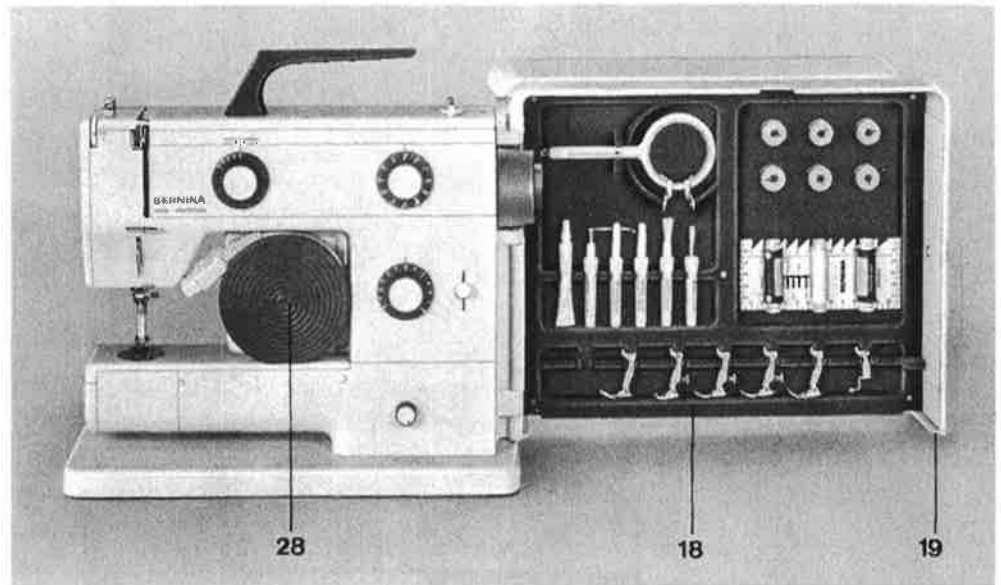

- | | |
|---|---|
| 1 Needle-plate | 14 Utilitystitchandbuttonholesettingknob |
| 2 Presser-foot | 15 Winder spindle |
| 3 Needle | 16 Handwheel |
| 4 Thread regulator | 17 Handwheel release |
| 5 Face-plate | 18 Accessories |
| 6 Lamp switch | 19 Front half of case |
| 7 Take-up lever | 20 Reverse sewing button |
| 8 Thread tension adjustment wheel | 21 Drop-feed control |
| 9 Winder pre-tension | 22 Stitch length adjusting knob |
| 10 Thread tension | 23 Free-arm cover-plate |
| 11 Carrying handle | 24 Free-arm |
| 12 Left-Center-Right adjusting knob
(needle position) | 25 Base-plate |
| 13 Stitch width adjusting knob (zigzag) | 26 Hinged cover |
| | 28 Foot starter |

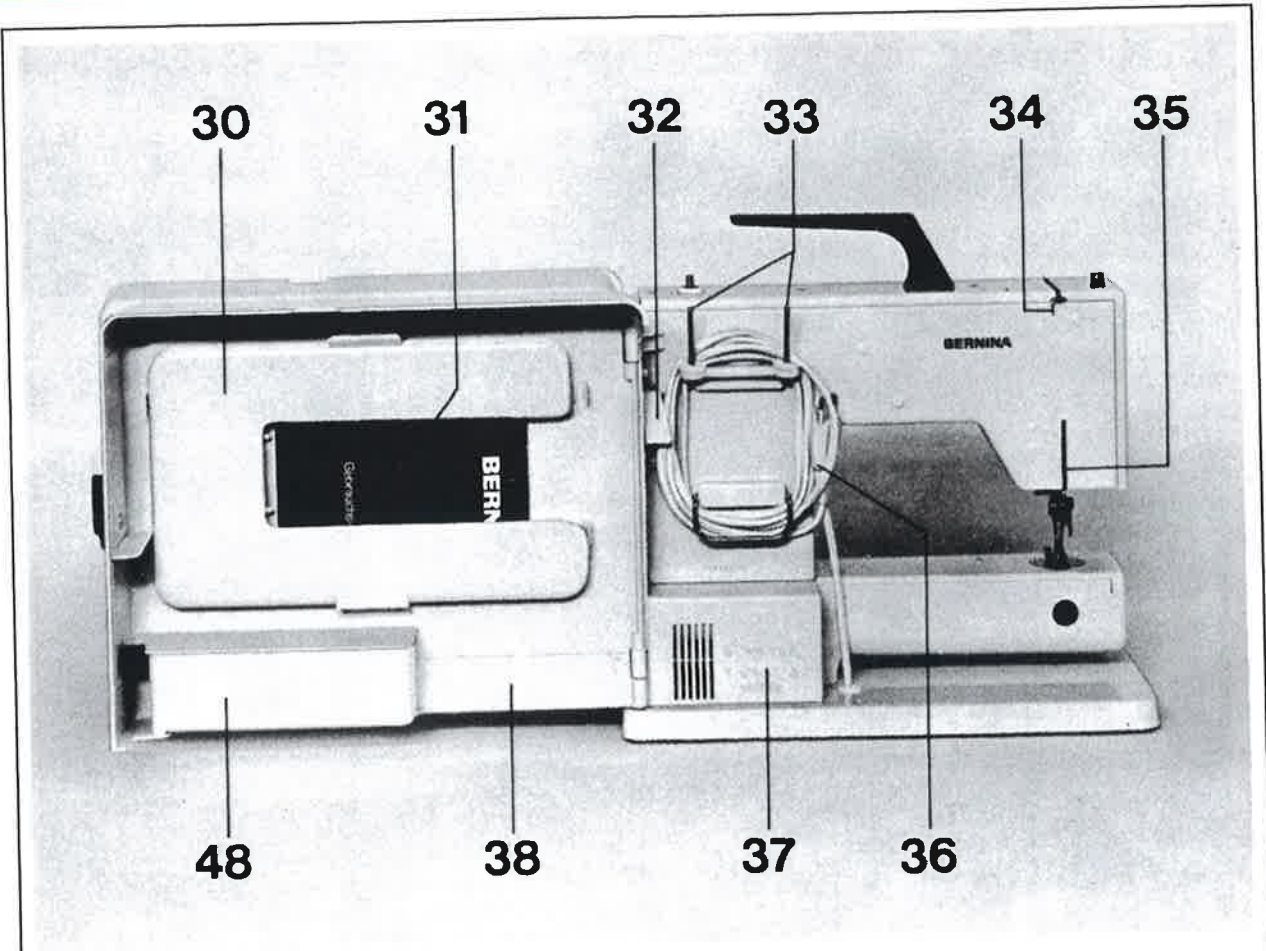

- 30** Attachment table
- 31** Operating instructions
- 32** Lever for removing or replacing the two swivelling halves of case
- 33** Reel pins

- 34** Reversing eye
- 35** Lifter lever
- 36** Power cable
- 37** Elec. ratings
- 38** Rear half of case
- 48** Accessories box

Opening of case

Pull fastening knob (27) forward slightly and unhook. The two halves of the case can then be swung right out. The machine is shown with case open on page 3.

The foot starter (28) is accommodated on the free-arm. The circular foot control is at the front.

The attachment table and operating instructions can be found in the rear half of the case.

It is preferable to keep the two halves of the open case together with the fastener (27).

Ensure when closing the case that the power and foot starter cable is properly coiled.

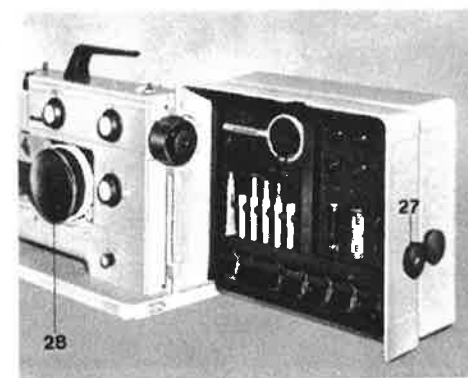
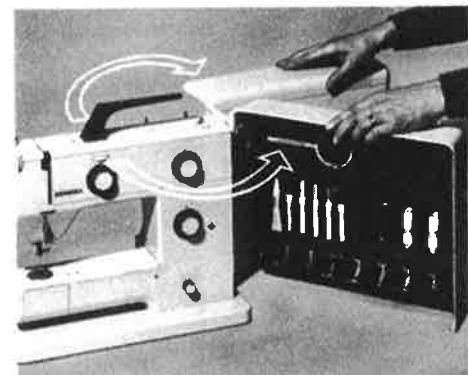
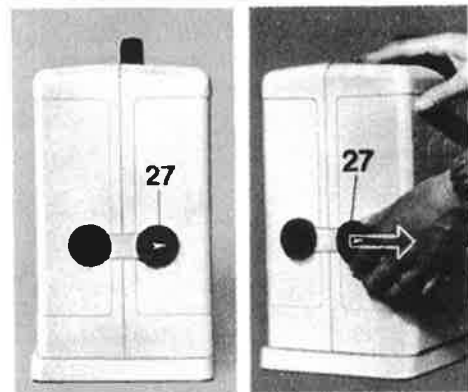

Removal of case from machine

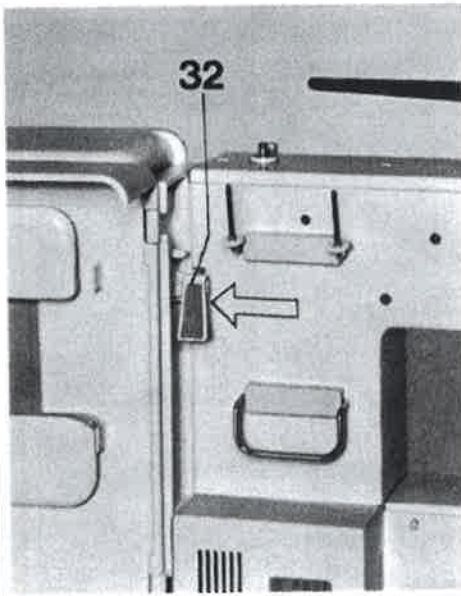

By raising the latch (32) the hinge plate is detached from the machine and the two halves of the case can be removed completely. Before removing the case, it is recommended to secure the two swivelling parts of the case in the open position by means of the fastener (27).

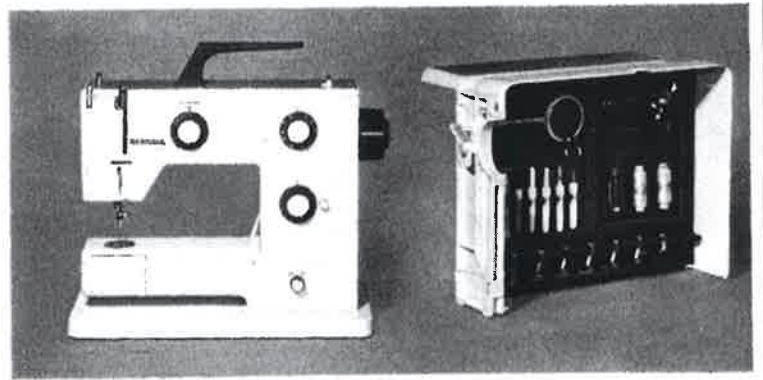
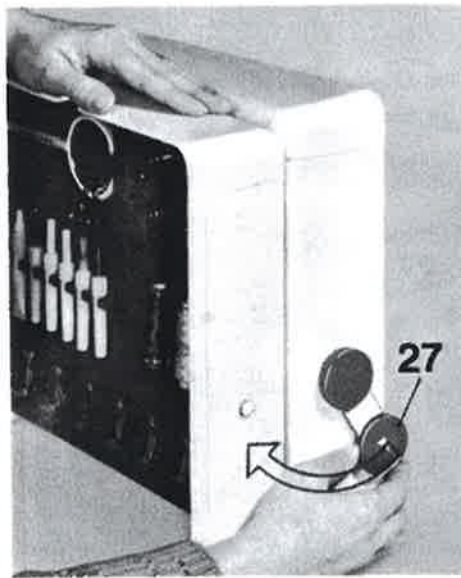

When re-attaching to the machine, the case should first be placed in the recesses provided in the base-plate and then tilted forward towards the handwheel.

Ensure that the locating pin (46) on the hinge plate engages in the circular opening (above the handwheel).

Re-attach case with lever (32).

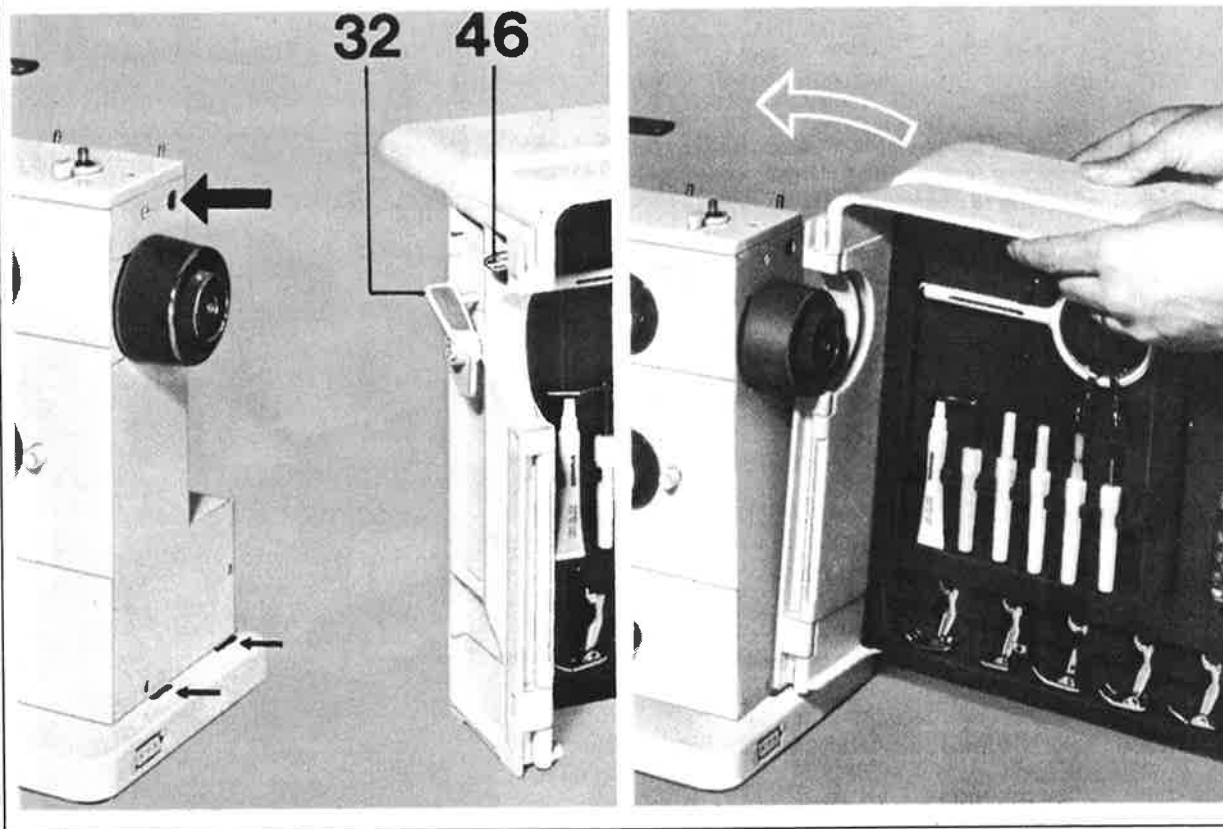

Electrical equipment

Note: First compare the supply voltage available with the value specified on the machine.

Connection:

Plug in special foot starter plug by base-plate on handwheel side. Locating lug on plug faces rear (see diagram). Uncoil power cable (36) from holder and connect plug to nearest socket.

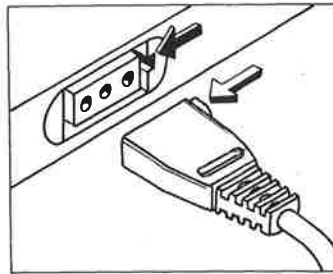

The machine can be started by applying light pressure to the foot starter switch.

Your Bernina machine is fitted with an electronic speed regulator. The stitch number is therefore fully variable with the motor running on full power.

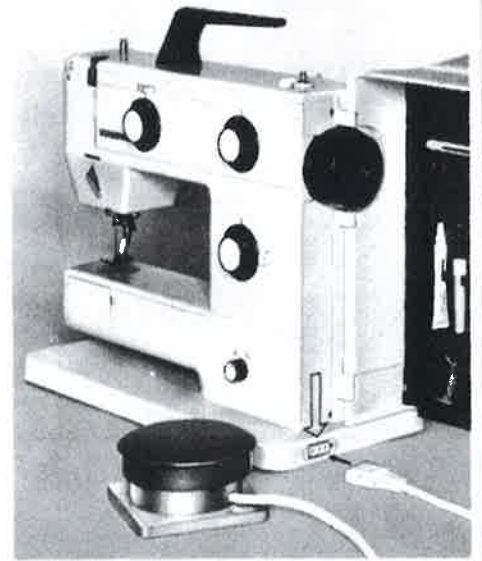
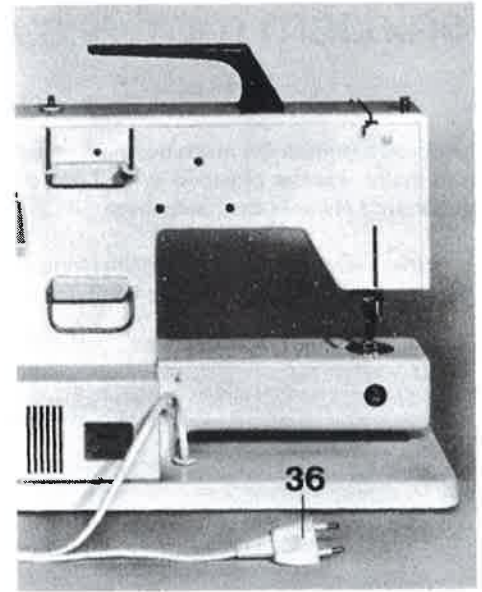

The sewing lamp

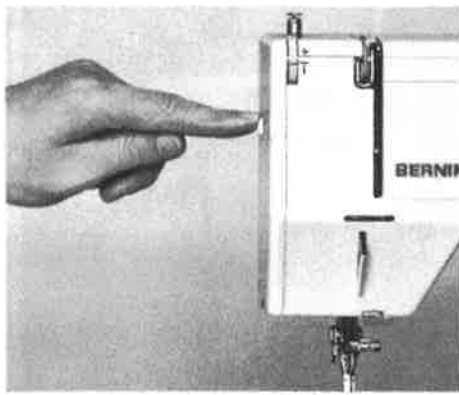

The built-in, non-glare sewing lamp is switched on and off by pressing switch (6).
(Sewing lamp: 15 W)

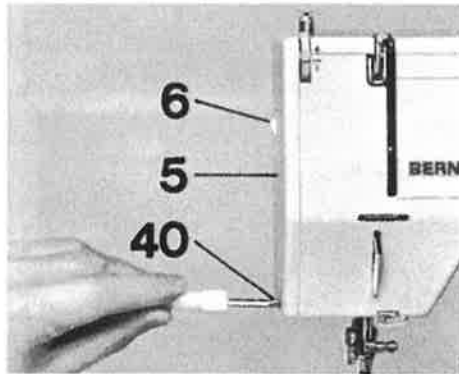

To change the bulb, release screw (40) and remove face-plate (5).

Press the bulb upwards, turn to the left and draw out downwards.

Replace in reverse sequence. Fit face-plate and re-tighten screw (40).

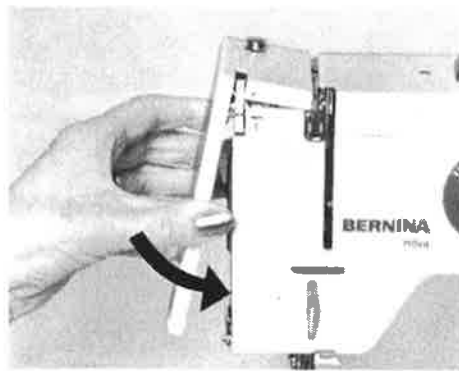

Ensure that when removing and replacing the face-plate, switch (6) is at the position shown in the diagram.

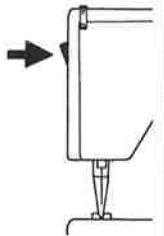

Bobbin case and bobbin

Removing the bobbin case:

Open hinged cover, turn handwheel (towards you) until the needle is raised.

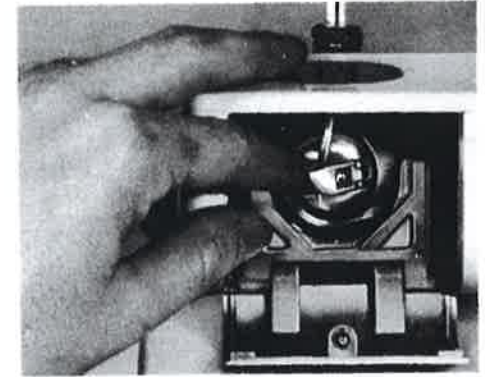
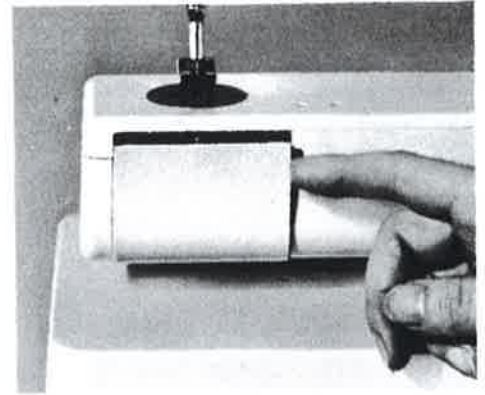

Take hold of bobbin case by small hinged flap and remove (using thumb and forefinger of left hand).

The bobbin case is replaced in the opposite sequence.

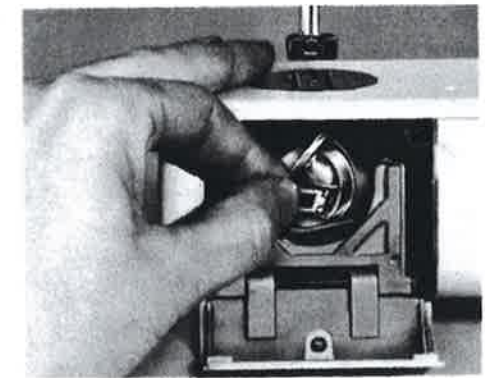

Needle and thread table

Needle system 705 B	very fine	fine	medium	strong	coarse
	60	70		80	90
Mercerised sewing thread (3-ply)		70-60	60-50	50-40	40
Darning thread (2-ply) Switzerland Abroad		140-120 70-60	100 50		

Correct choice of needle and thread.

Use only needle system 705 B for Bernina models 900.

Please ensure that the correct combination of needle and thread as shown in the table above is used.

The usual needles, numbers 80, 90 and 100, are used for sewing and number 70 and 80 for darning.

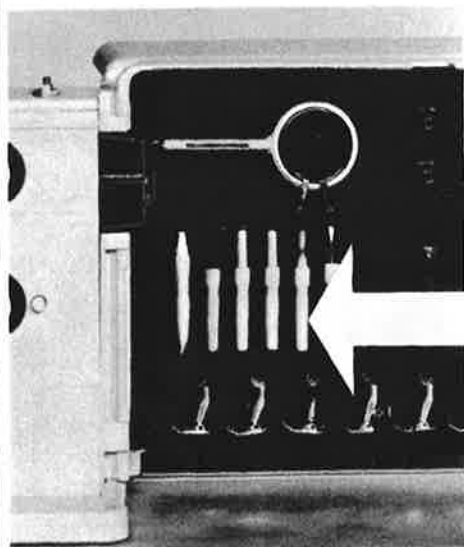

The cleaning brush in the accessories is also used as a needle holder (see drawing). To open, remove upper part of brush (bristle end).

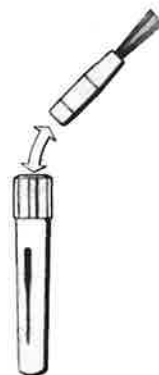

Winding bobbin thread

Release handwheel:

Hold handwheel with the left hand. Release with right hand by turning the knurled screw counter-clockwise.

Place bobbin on bobbin spindle and press downwards. Winder is then switched on.

Draw thread from reel clockwise round the pre-tensioning (9) and take from there – as shown in picture – to the bobbin which is in position. Start motor with foot control. As soon as the bobbin is full, the winding action stops automatically.

Remove bobbin from winder spindle and then re-tighten knurled screw on handwheel.

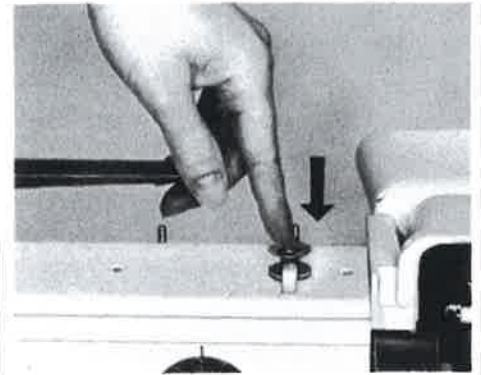
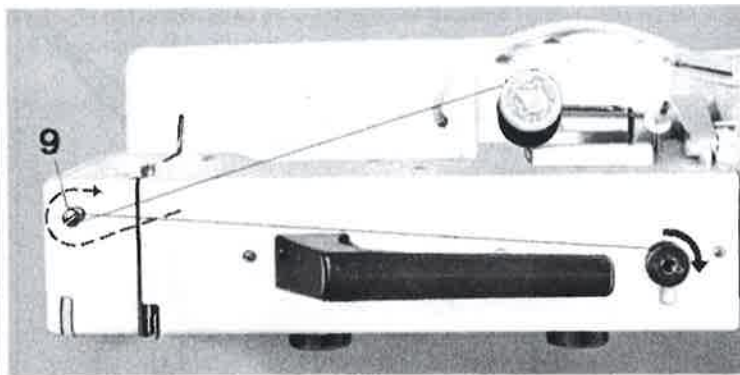
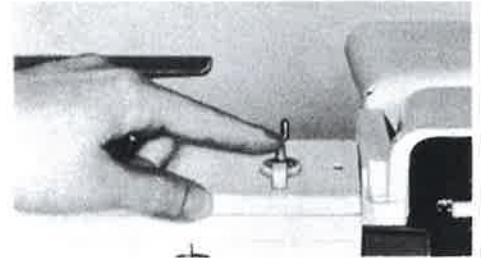

Inserting the bobbin

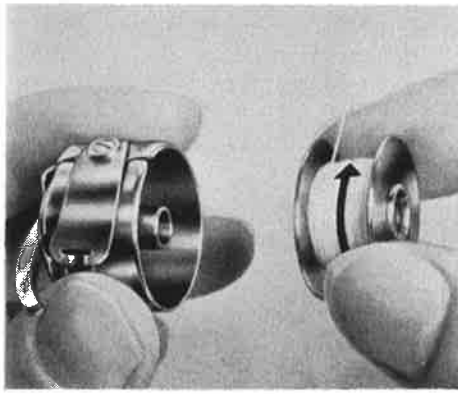

Place bobbin in bobbin case so that the thread unwinds in the direction of the arrow.

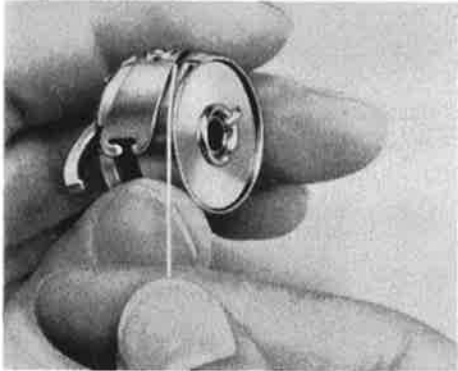

Draw thread through slot and then under tension spring (do not hold bobbin during this operation).

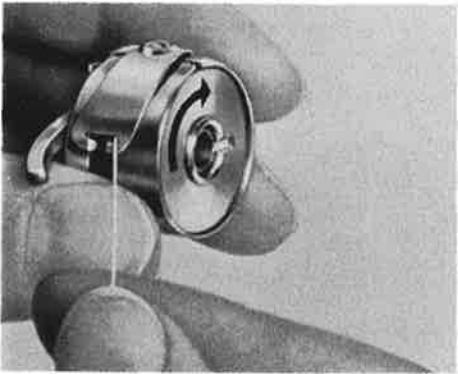

The bobbin must turn in the direction of the arrow as the thread unwinds.

Insertion of bobbin with case into the hook

Turn handwheel and bring needle to top position. Hold the bobbin case by the hinged flap as when removing (using thumb and forefinger of the left hand).

To insert, hold the bobbin case in such a way that the beak points upwards and fits into the notch of the hook race cover (see section entitled «Bobbin case and bobbin»).

Check: Pull loose end of thread.

Inserting the needle

Loosen the clamping screw half a turn. Push the needle vertically up to the stop with the flat face to the rear. Securely re-tighten clamping screw (use screwdriver).

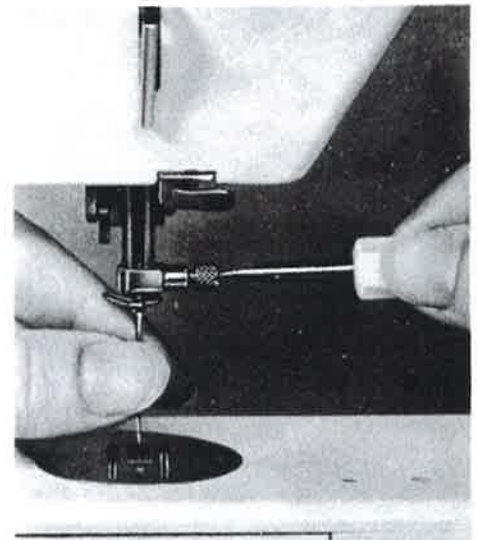

Threading aid

The most commonly used Bernina presser feet have a white plate on their shank.

Set the needle with the handwheel sufficiently high so that the eye of the needle lies in front of the white plate. This makes it far more distinct and threading becomes considerably easier.

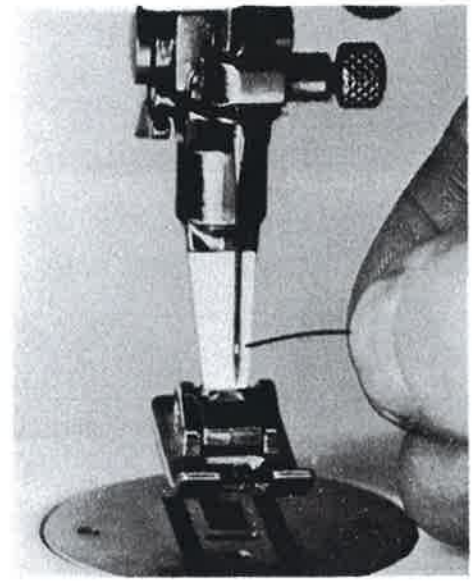

Threading the upper thread

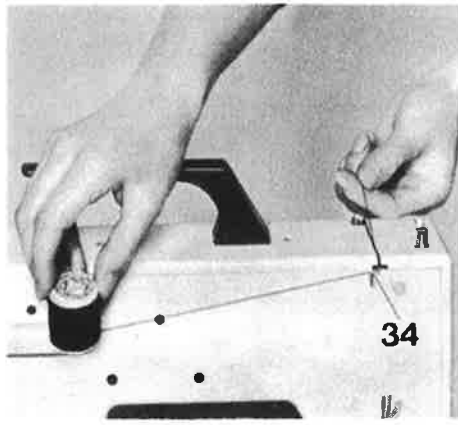

Threading of the upper thread from reel to needle is performed in one operation with the Bernina.

When threading, the presser foot and take-up lever should in principle be raised.

Place reel in position. Guide end of thread with left hand through the eyelet (34) and then draw it through the long slot of the thread tension. The right hand is used to hold the reel steady to ensure that the thread is drawn into the thread tension.

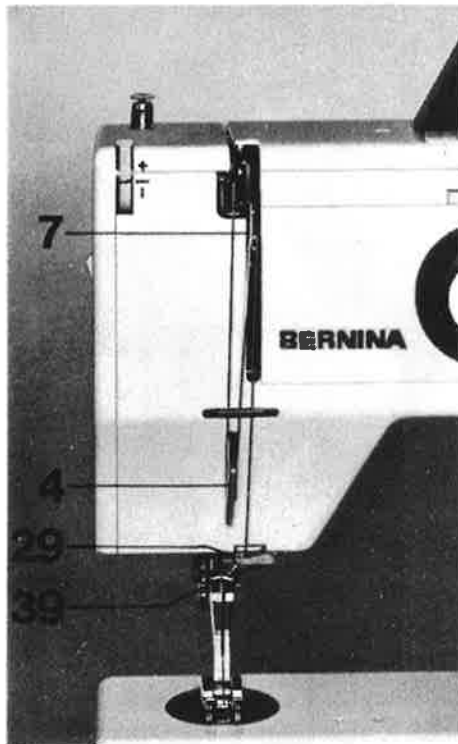

Then guide thread into the thread regulator (4), draw upward through the slot of the take-up lever (7) and then down to eyelets (29) and (39).

Finally thread the end through the eye of the needle **from front to rear** and leave about 10 cm loose.

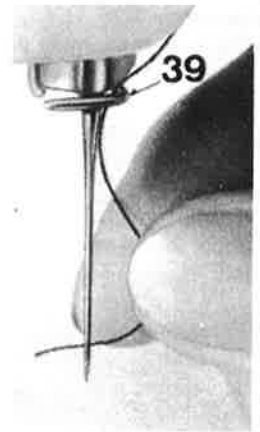

Bringing up the bobbin thread

Hold end of threaded upper thread loosely. Then turn handwheel one revolution towards you while simultaneously drawing the end of the upper thread lightly. The bobbin thread then comes up through the needle hole.

Slightly tension the upper and lower thread and lay them sideways under the presser foot.

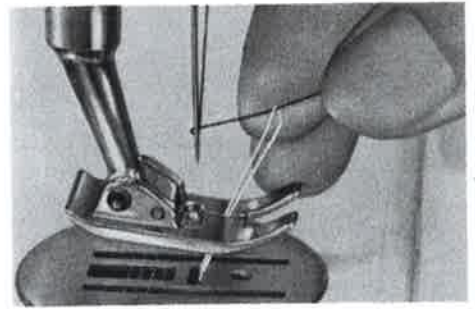

Lowering the feed dog

For certain types of sewing, darning in particular, the feed dog must be lowered.

Sewing:

For all normal sewing work the mark on knob 21 must point to the symbol for sewing 

Darning:

The knob mark must point to the symbol for darning
Feed dog lowered (no material feed).

Removing the work from the machine:

When sewing is finished raise the take-up lever (7) using the handwheel.

Then lift presser foot with lifter lever (35). This releases the tension of the upper thread and the work can easily be withdrawn backwards and to the left.

Threading aid:

The presser foot attachment lever is designed so that it can also be used as a thread cutter.

This little device saves a lot of time, particularly when scissors are not close at hand.

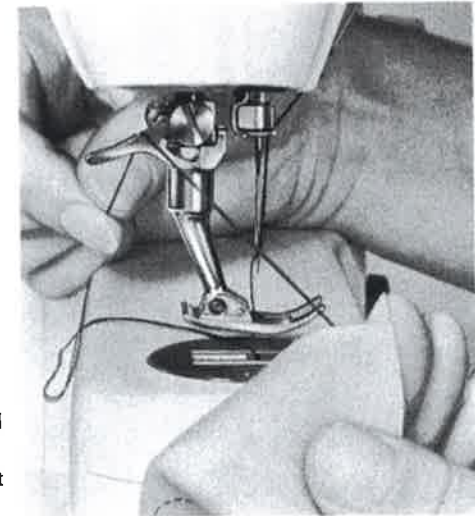
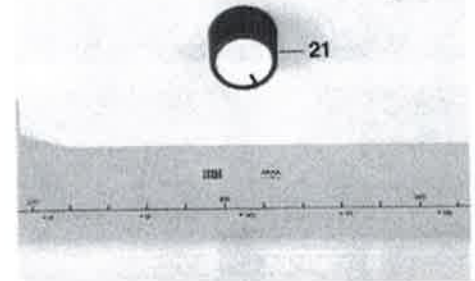

Thread tension

THE BERNINA OFFERS THE UNIQUE ADVANTAGE THAT FOR ALL NORMAL SEWING THE THREAD TENSION DOES NOT HAVE TO BE ALTERED.

For special purposes, the tension can be adjusted with the regulating wheel (8).

As a rule-of-thumb it may be taken that normal tension = mark on regulating wheel (8) must coincide with marking line on the frame.

Turning the regulating wheel (8) in the direction « + » increases the tension, while turning in the « - » direction decreases it.

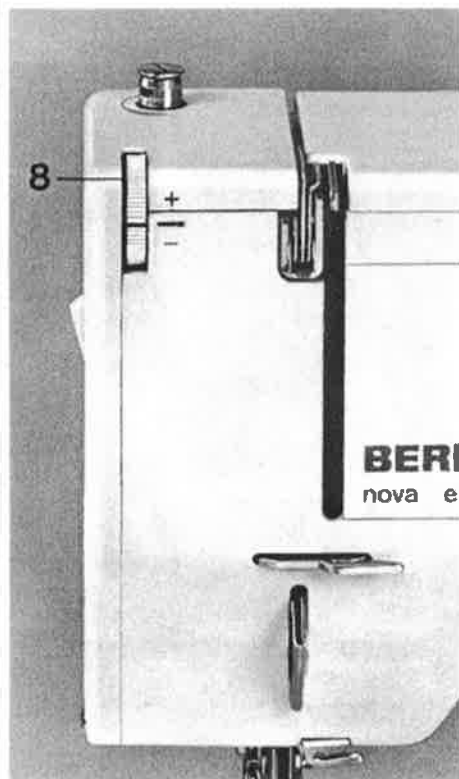

Attachment table

The attachment table (30) is accommodated in the rear half of the carrying case.

The securing angle (41) must be pressed slightly upwards to remove the table.

Push table over free-arm until the centering pins (43) locate with the corresponding holes (44). By pushing firmly in the direction of the arrow, the attachment table can be secured with its fixing on pins (45).

Removal of attachment table:

The attachment table can be released from its fixing with a powerful push to the left (away from the machine).

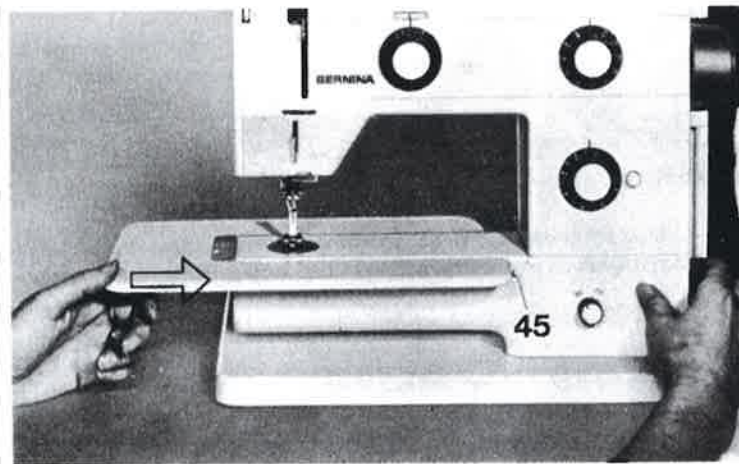
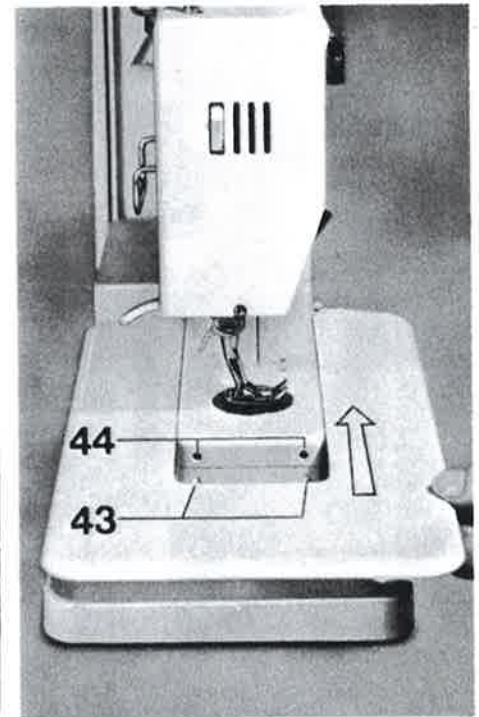
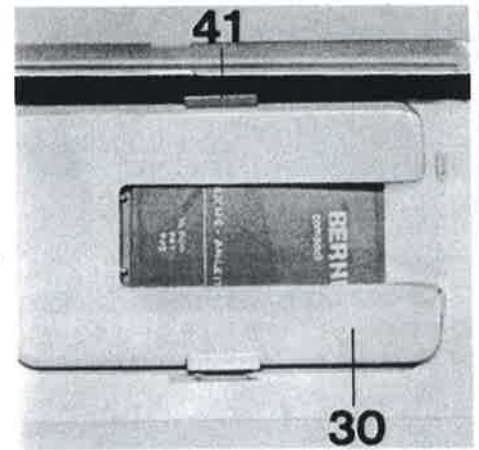

Changing the presser foot

Use the correct presser foot for each type of sewing work — only in this way will sewing become simple and satisfactory. The Bernina method of attaching the presser foot makes it easy and straightforward to change. The Bernina principle «just clip on the presser foot» makes sewing even more rapid.

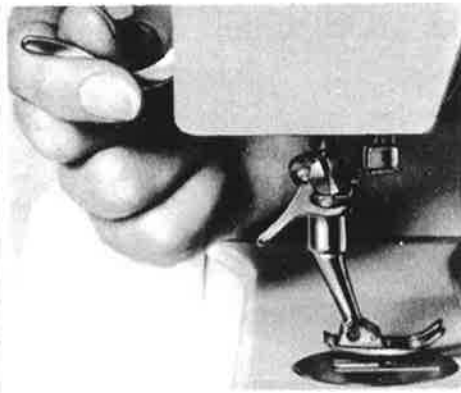

Raise presser foot with lifter lever.

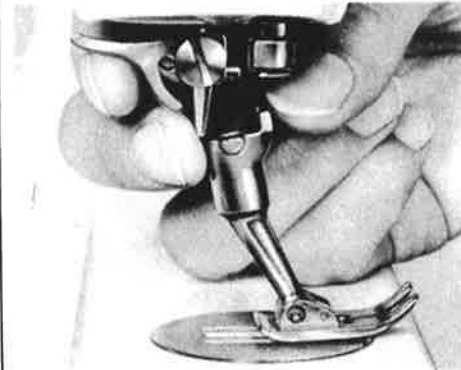

Release fixing lever and remove presser foot.



Fit required presser foot and press fixing lever downwards.

The presser foot is firmly secured and the machine ready for fresh sewing work.

Needle position

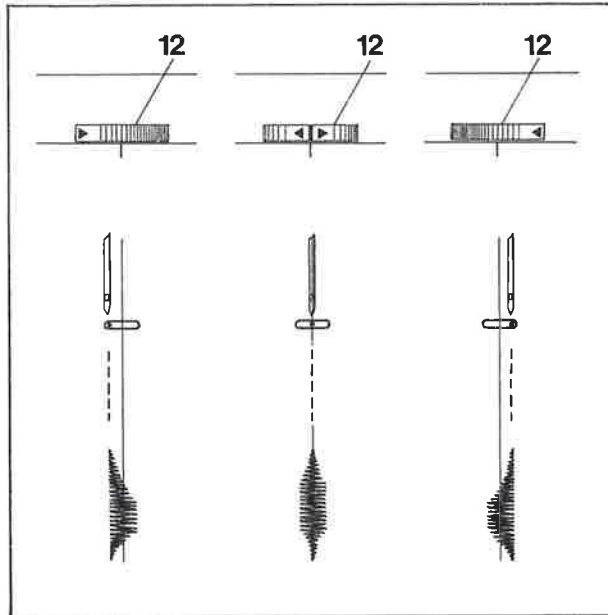

The needle can be set to right or left for blind seam sewing, inserting zips, etc. by means of the needle position adjusting wheel (12).

Left – Center – Right).

For special sewing work, a half-left and half-right position are also available.

For normal sewing the needle remains in the center.

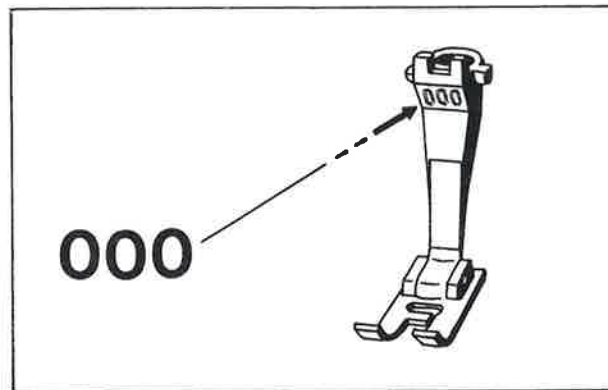



Presser foot designations:

Zigzag presser foot	000
Blindstitch foot	016
Zip foot	007
Overlock foot	470
Embroidery foot	030
Buttonhole foot	452
Darning foot	285

Straight stitch sewing

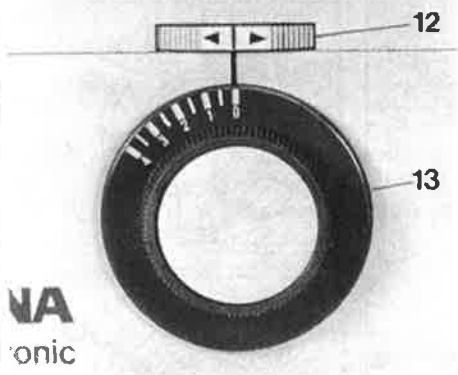
NA
onic



Knob (14) to symbol ----- (straight stitch)
Knob (13) to 0
Feed dog lowering knob (21) to  (sewing)
Needle position (12): center
Set desired stitch length (knob 22)
(normal stitch length approx. 1.5)
Presser foot 000 can be used

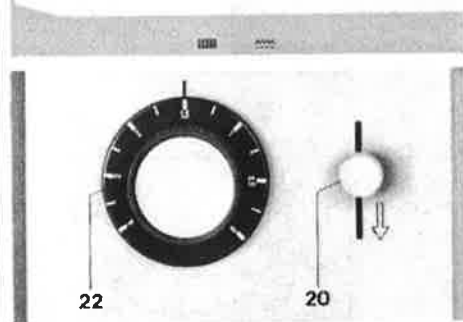
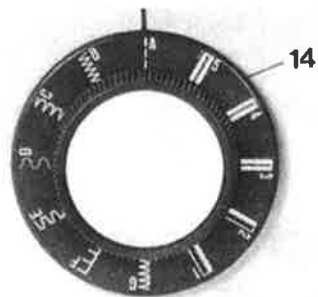

Reverse sewing

For reverse sewing press scanner button (20) down in direction of arrow. This knob is spring-loaded. When released, the machine sews forwards again. The length of the reverse stitch approximately corresponds to the forward stitch set in the range 0 – 2.

Zigzag sewing

Ensure when zigzag sewing that selector knob (14) is set to symbol (zigzag).

Set zigzag or stitch width with selector knob (13). The scale on knob (13) allows the zigzag or stitch width to be read in conjunction with the marking line on the frame.

If the knob is turned to the right — from 0 to 4 — the needle displacement becomes greater. The higher the number, the wider the zigzag stitch.

If the 0 is opposite the marking line, the machine sews a straight stitch. The knob can be adjusted while sewing, but, when stationary, only if the needle is out of the material.

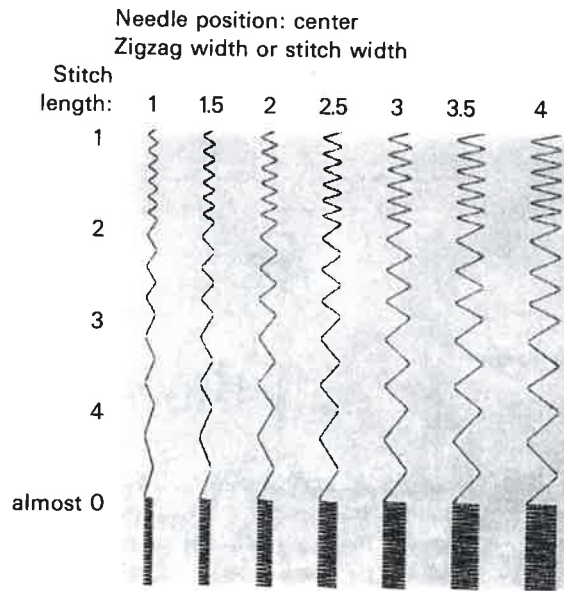
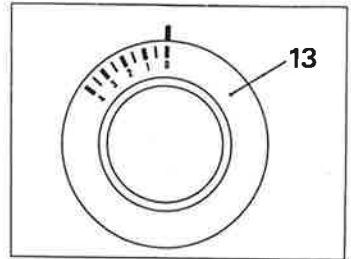
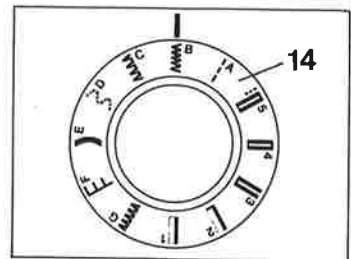

Stitch length — satin stitch

The stitch length (straight stitch) or satin stitch spacing (zigzag stitch) can be regulated with knob (22). Fine regulation is possible between 0 and 1.5.

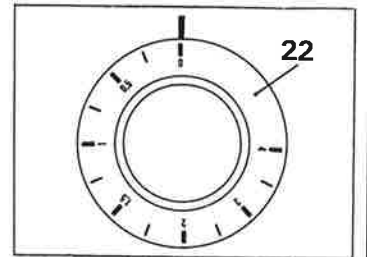

Utility stitches

Knob (14) permits the choice of various utility stitches.

The various utility stitches which can be sewn with Bernina model 900:

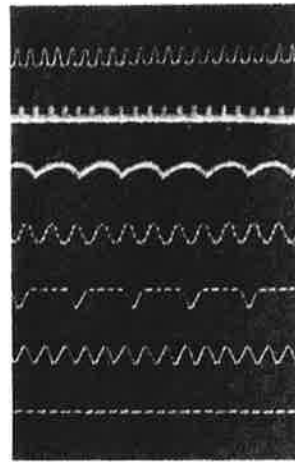
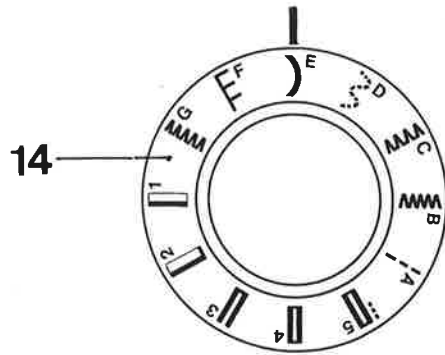

- G overlock
- F stretch seam
- E scallop seam
- D bow stitch
- C blind stitch
- B zigzag
- A straight stitch

Automatic buttonhole sewing

Settings:

Stitch width adjusting knob (13) to stitch width: 4

Turn knob (14) so that buttonhole symbol No. 1 is opposite the marking line.

L-C-R adjusting knob (12) to center position.

Knob 21 to  (sewing)

Set satin stitch spacing, i.e. knob (22) to stitch length: almost 0.
The satin stitch spacing can be finely adjusted within the range 0–0.5 by means of knob (22), depending on material and thread.

Foot used: buttonhole foot 452.

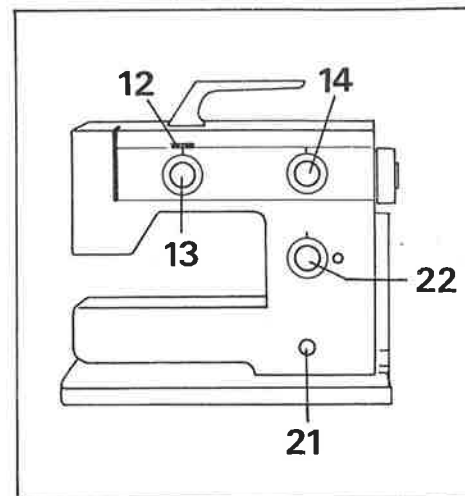

For sewing buttonholes, thread the lower thread through finger of bobbin case.

It is best to check the satin stitch spacing on a spare piece of material before starting to sew.

Before starting, move needle downwards to about foot height and check whether needle is in the middle of the presser foot slot.

If not, turn the handwheel one revolution until the needle is raised again.
But under no circumstances alter position of zigzag and needle.
Now insert work under foot and set needle exactly at start of buttonhole.

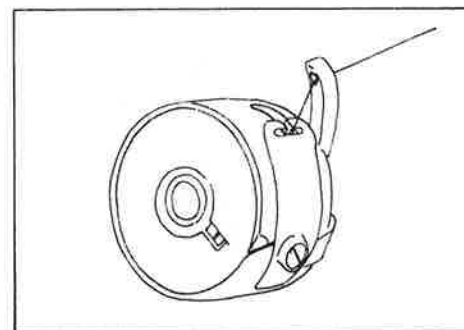

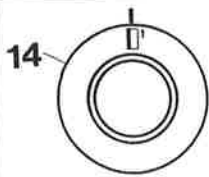

1

Sew the first bead forwards

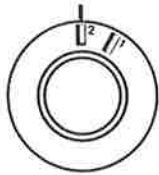

2

Raise needle
Turn knob (14) further to buttonhole symbol 2 – machine sews the bar tack

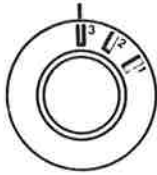

3

Needle raised
Set knob to 3 – machine sews second bead backwards

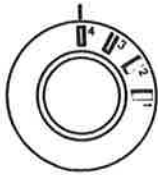

4

Needle raised
Set knob to 4 – machine sews bar tack

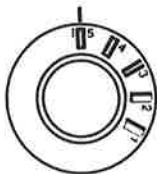

5

Needle raised
Set knob to 5 – sew finishing stitches

If further buttonholes must be sewn, return knob (14) to symbol 1.
Continue sewing as described above.

Cleaning and oiling

If the sewing machine is kept in a cold room, it should be placed in a warm room about 1 hour before use to enable it to attain room temperature. This allows the oil in the bearing to flow more freely.

Cleaning the machine. Scraps of thread collect under the needle plate and around the shuttle while sewing. The cover-plate of the free-arm should therefore be removed occasionally in order to remove this sewing fluff.

Removing cover-plate from free-arm. Remove presser foot and needle, open hinged cover. Hold cover-plate with the left hand and at the same time press with the forefinger of the right hand on the releasing lever.

After removing the cover the feed-dog is accessible and can be thoroughly cleaned, as well as the lower side of the needle plate on the arm cover.

Cleaning and oiling the hook. 1 or 2 drops of oil from time to time. Take out bobbin case. Press latch to the left with forefinger of right hand. The locking strap with the hook race cover can then be folded down.

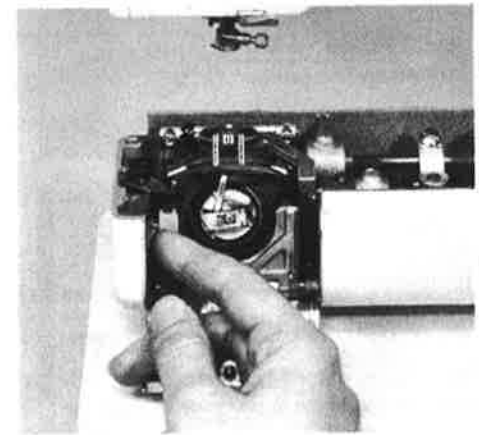
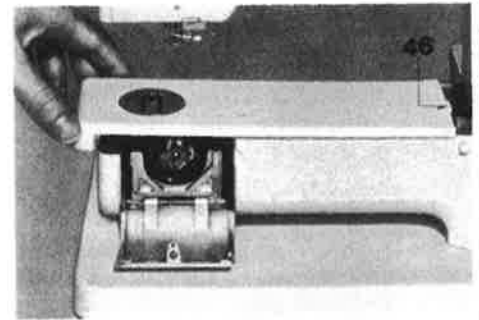
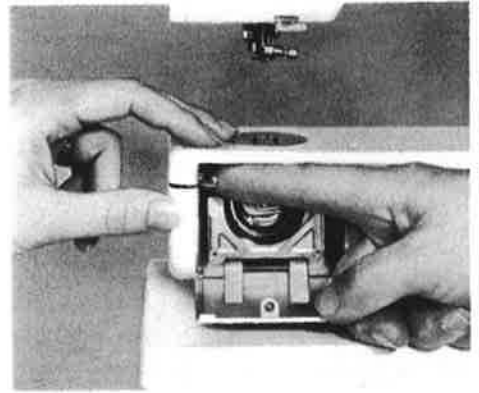

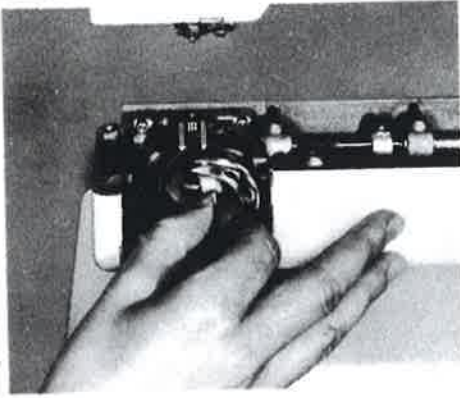

The hook can then be taken out and the hook race cleaned with the brush and a cotton cloth. Never use hard objects (screwdrivers, scissors) to remove scraps of thread.

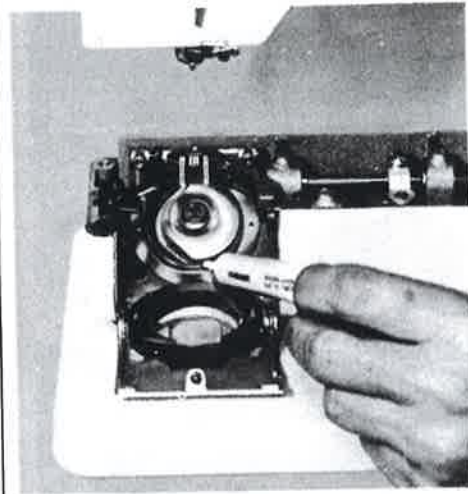

After cleaning, add a few drops of oil to the hook race.

Then replace the hook in the race with the left hand. Close the race cover and fastening strap. The securing latch must engage properly. Check by turning the handwheel. Replace free-arm cover. Ensure that the cover plate locating piece (46) enters the guide provided on the frame. Then press arm cover down. The securing latch engages automatically. After inserting the bobbin case the hinged cover can be re-closed.

Safety instructions

Please pay attention to the sewing position while working.

The moving needle is a source of danger (damaged fingers).

When changing the needle, presser foot, bobbin, needle plate, or when work is interrupted without supervision, or during cleaning, the machine should be disconnected from the power supply by removing the plug from the socket.

Fault prevention — some useful tips

1. General remarks. In most cases breakdowns are caused by improper operation of the machine. If faults occur, then check whether:

- a) the needle is inserted properly. (The flat side of the needle must be at the back)
- b) the correct needle is being used (see needle and thread table)
- c) the machine is cleaned properly. Remove free-arm cover plate and brush off scraps of thread.
- d) the hook race is clean and lubricated
- e) there are pieces of thread lodged between the thread tension disks and beneath the bobbin case spring
- f) the handwheel is properly secured

2. Breakage of upper thread. Can be caused as follows:

- a) upper thread is too tight
- b) use of inferior needles (it is best to buy needles from a Bernina dealer)
- c) needle wrongly inserted. Flat side must be at **back**
- d) needle is blunt or bent
- e) poor quality thread or thread with knots. Thread has dried out during long storage

f) the needle plate hole is pitted by the needle and needs repolishing (take free-arm cover to Bernina dealer)

g) the hook point is damaged (contact Bernina dealer)

3. Breakage of lower thread. Can be caused by the following:

- a) lower thread is too tight
- b) the bobbin is crushed and jammed in the case; replace bobbin
- c) the needle plate hole is pitted by the needle and needs repolishing (change needle plate by Bernina dealer)

4. Faulty stitches. Can be caused by the following:

- a) use of wrong needles. Use only needles of System 705
- b) needle is bent or not properly inserted (push needle right up when inserting)
- c) poor quality, roughly polished needles

5. Broken needles can be caused as follows:

- a) the needle clamping screw is not tightened sufficiently
- b) the work was withdrawn forwards beneath the presser foot, therefore bending and twisting the needle (always remove work from the back)

c) while sewing over thick section, the work was moved while needle was in material. This also bends it and it breaks against the needle plate

d) use of cheap thread which is unevenly twisted or has knots

6. Faulty seams. A poor, uneven seam is produced:

a) if scraps of thread are left between the thread tension disks

b) if there are scraps of thread beneath the bobbin case tension spring

7. Machine runs slowly

a) motor does not function properly (call Bernina dealer)

b) Foot starter does not function properly (call Bernina dealer)

c) Tension of driving belt is too tight or too loose

d) Machine taken from cold room

Cleaning of the white rubber coating on the foot control

Moisten a cleaning rag in luke-warm soapy water and clean the rubber with it.

Caution! No water should penetrate the foot control housing.

If you take your machine for inspection, please always bring accessories and foot starter.